



# Aqua TROLL 600

## Operator's Manual



Information subject to change without notice. In-Situ, In-Situ logo, “Water Simplified”, VuLink, RDO, RuggedCable, TROLL, BaroTROLL, HydroVu, VuSitu, Baro Merge, and Win-Situ are trademarks or registered trademarks of In-Situ Inc. ©2026. All rights reserved. This product may be covered by patents identified at [www.in-situ.com/patents](http://www.in-situ.com/patents)



For a list of local compliance representatives, see <https://in-situ.com/compliance-information>

Contains FCC ID: QOQ-GM220P  
Contains IC: 5123A-GM220P

# Contents

<b>Introduction</b> .....	<b>12</b>
Serial Number Location.....	12
Instrument Description .....	12
Document Conventions.....	12
Unpacking and Inspecting .....	12
<b>Safety</b> .....	<b>13</b>
Safety and Damage Warnings .....	13
Intended Use.....	13
<b>Getting Started</b> .....	<b>14</b>
Box Contents.....	14
<b>Required Accessories</b> .....	<b>17</b>
Communication Device .....	17
Telemetry + Communication Device.....	17
Software .....	17
Rugged Twist-Lock Cable .....	18
Sensors.....	19
<b>System Components</b> .....	<b>20</b>
<b>LCD Screen</b> .....	<b>23</b>
Starting a Basic Log .....	23
Possible Port Statuses .....	23
Possible Power Statuses.....	23
Possible Log Statuses .....	23
Possible Connected Statuses .....	23
Error Messages.....	23
Micro SD Card.....	24
<b>Calibrating Sensors</b> .....	<b>26</b>
Calibration in VuSitu.....	26
Calibrating with a copper Restrictor .....	26
Factory Calibration .....	26
<b>Batch Calibrating Sensors in VuSitu</b> .....	<b>27</b>
Multiple Sensors of the Same Type .....	27
Different Sensor Types (Quick Cal Solution) .....	28
<b>Reported Depth</b> .....	<b>29</b>
<b>Navigating VuSitu</b> .....	<b>30</b>
Connecting to VuSitu.....	30
Connected Instrument Screen .....	30
Logging in With HydroVu .....	31

VuSitu Menu Options .....	32
Selecting with Long-press and Swipe.....	32
<b>Live Readings in VuSitu.....</b>	<b>33</b>
Snapshot Mode.....	33
Live Readings Mode.....	33
<b>VuSitu Locations .....</b>	<b>34</b>
About VuSitu Locations .....	34
How to Create a Location .....	34
How to Edit or Delete a Location .....	34
How to Select a Location.....	35
<b>Wiper Interval Settings .....</b>	<b>35</b>
<b>Instrument Bluetooth.....</b>	<b>35</b>
Disabling Instrument Bluetooth .....	35
<b>Logging.....</b>	<b>36</b>
Creating a Log with VuSitu .....	36
Downloading and Managing Data.....	36
<b>Remote Monitoring with VuLink .....</b>	<b>37</b>
Claim VuLink. ....	37
Configure and deploy. ....	37
Connect the instrument. ....	37
View data in HydroVu.....	37
<b>HydroVu .....</b>	<b>38</b>
<b>Connecting to a PLC or Data Logger .....</b>	<b>39</b>
Flying Leads Wire Diagram .....	39
SDI-12 wiring diagram .....	40
Modbus (RS485) wiring diagram .....	41
Modbus (RS232 with converter) wiring diagram.....	42
<b>Configuring SDI-12 Settings .....</b>	<b>43</b>
About SDI-12 .....	43
Configure SDI-12 Settings in VuSitu.....	43
<b>Modbus PLC Interface .....</b>	<b>43</b>
Overview .....	43
Setting Up Instrument.....	44
Programming the PLC .....	44
Reading Device Information.....	44
Reading Parameters .....	45
Turning on Instrument Bluetooth with a PLC.....	45
<b>Care and Maintenance .....</b>	<b>46</b>
Storage .....	46
Cleaning the Sonde .....	46

Removing the Restrictor .....	46
Cleaning the Copper Restrictor .....	46
Factory Maintenance Schedule.....	47
User-Serviceable Parts .....	47
Sensor Maintenance .....	47
Wiper Maintenance.....	47
<b>Aqua TROLL Sensors.....</b>	<b>48</b>
Sensor Options .....	48
Installing Sensors .....	48
Removing Sensors .....	48
Sensor Summary .....	49
Solutions Summary.....	50
Fluorometer Wavelengths.....	50
<b>Conductivity and Temperature Sensors.....</b>	<b>51</b>
About the Sensor .....	51
How It Works.....	51
Best Practices for Fast Temperature Response Time.....	52
Preferred Temperature.....	52
Specific Conductivity.....	52
Resistivity .....	52
Salinity .....	53
Density .....	53
Total Dissolved Solids (TDS).....	53
Additional Information.....	53
Chemical Incompatibility .....	54
Cleaning .....	54
Recommended Calibration Frequency.....	55
1-Point vs 2-Point Calibrations .....	55
Choosing Calibration Standards .....	55
Calibration Procedure .....	56
Shelf Life for In-Situ Solutions .....	56
Checking Calibration Quality .....	57
Maintenance .....	57
Storage .....	57
Expected Sensor Life .....	57
<b>pH/ORP Sensor .....</b>	<b>58</b>
About the Sensor .....	58
How pH Measurement Works.....	58
How ORP Measurement Works .....	59
Potential Interferents .....	59

Expected Sensor Life .....	59
Additional Information.....	59
Chemical Incompatibility .....	60
Installation Requirements.....	60
Preparing the pH/ORP Sensor.....	60
Cleaning .....	61
Recommended Calibration Frequency.....	62
Calibration Procedure .....	62
Checking Calibration Quality .....	63
Shelf Life for In-Situ Solutions .....	63
Replacing the Sensor Fill Solution and Reference Junction .....	64
Storage .....	64
<b>Rugged Dissolved Oxygen (RDO®) Sensor .....</b>	<b>65</b>
About the Sensor .....	65
How It Works.....	65
Dissolved Oxygen Concentration.....	66
Dissolved Oxygen Saturation .....	67
References.....	67
Potential Interferents .....	67
Compensation for Other Parameters.....	67
RDO Cap Chemical Incompatibility.....	68
Cleaning the Sensor.....	68
Installation Requirements.....	68
Recommended Calibration Frequency.....	68
RDO 100% Saturation Calibration: Water Saturated Air .....	69
RDO 100% Saturation Calibration: Saturation Bubbler .....	69
RDO 0% Saturation: Sodium Sulfite.....	70
RDO Concentration.....	70
Checking Calibration Quality .....	71
Shelf Life for In-Situ Solutions .....	71
Replacing the RDO Cap .....	72
Storage .....	72
Expected Sensor Life .....	72
<b>Turbidity Sensor .....</b>	<b>73</b>
About the Sensor .....	73
How It Works.....	73
Total Suspended Solids (TSS) .....	74
About Turbidity Calibration Standards.....	74
Additional Information.....	74
Chemical Incompatibility .....	75

Cleaning .....	75
Choosing Calibration Standards .....	75
Recommended Calibration Frequency .....	76
Calibration Procedure .....	76
Checking Calibration Quality .....	77
Shelf Life for In-Situ Solutions .....	77
Maintenance .....	77
Storage .....	77
Expected Sensor Life .....	77
<b>Ammonium Sensor .....</b>	<b>78</b>
About the Sensor .....	78
How It Works .....	78
Potential Interferents .....	79
Free and Total Ammonia Calculation .....	79
Additional Information .....	79
Chemical Incompatibility .....	80
Installation Requirements .....	80
Preparing Ion-Selective Electrode Sensors .....	80
Cleaning .....	81
Recommended Calibration Frequency .....	82
Calibration Procedure .....	82
Checking Calibration Quality .....	83
Shelf Life for In-Situ Solutions .....	83
Expected Sensor Life .....	83
Replacing the Sensor Fill Solution and Reference Junction .....	84
Storage .....	84
<b>Nitrate Sensor .....</b>	<b>85</b>
About the Sensor .....	85
How It Works .....	85
Potential Interferents .....	86
Additional Information .....	86
Chemical Incompatibility .....	87
Installation Requirements .....	87
Preparing Ion-Selective Electrode Sensors .....	87
Cleaning .....	88
Recommended Calibration Frequency .....	89
Calibration Procedure .....	89
Checking Calibration Quality .....	90
Shelf Life for In-Situ Solutions .....	90
Expected Sensor Life .....	90

Replacing the Sensor Fill Solution and Reference Junction .....	91
Storage .....	91
<b>Chloride Sensor .....</b>	<b>92</b>
About the Sensor .....	92
How It Works .....	92
Potential Interferents .....	93
Additional Information .....	93
Chemical Incompatibility .....	94
Installation Requirements .....	94
Preparing Ion-Selective Electrode Sensors .....	94
Cleaning .....	95
Recommended Calibration Frequency .....	96
Calibration Procedure .....	96
Checking Calibration Quality .....	97
Shelf Life for In-Situ Solutions .....	97
Expected Sensor Life .....	97
Replacing the Sensor Fill Solution and Reference Junction .....	98
Storage .....	98
<b>Chlorophyll a Sensor .....</b>	<b>99</b>
About the Sensor .....	99
How It Works .....	99
Potential Interferents .....	100
Fluorescence Wavelengths .....	100
Derived Parameters: Cell Count and Concentration .....	100
Additional Information .....	100
Installation Requirements .....	101
Chemical Incompatibility .....	101
Cleaning .....	101
Recommended Calibration Frequency .....	102
Calibration Procedure .....	102
Preparing Rhodamine WT Calibration Standard .....	103
Checking Calibration Quality .....	103
Shelf Life for In-Situ Solutions .....	104
Maintenance .....	104
Storage .....	104
Expected Sensor Life .....	104
<b>BGA-PC Sensor .....</b>	<b>105</b>
About the Sensor .....	105
How It Works .....	105
Potential Interferents .....	106

Fluorescence Wavelengths.....	106
Derived Parameters: Cell Count and Concentration .....	106
Additional Information.....	106
Installation Requirements.....	107
Chemical Incompatibility .....	107
Cleaning .....	107
Recommended Calibration Frequency.....	108
Calibration Procedure .....	108
Preparing Rhodamine WT Calibration Standard.....	109
Checking Calibration Quality .....	110
Shelf Life for In-Situ Solutions .....	110
Maintenance .....	110
Storage .....	110
Expected Sensor Life .....	110
<b>BGA-PE Sensor .....</b>	<b>111</b>
About the Sensor .....	111
How It Works.....	111
Potential Interferents .....	112
Fluorescence Wavelengths.....	112
Derived Parameters: Cell Count and Concentration .....	112
Additional Information.....	112
Installation Requirements.....	113
Chemical Incompatibility .....	113
Cleaning .....	113
Recommended Calibration Frequency.....	114
Calibration Procedure .....	114
Preparing Rhodamine WT Calibration Standard.....	115
Checking Calibration Quality .....	116
Shelf Life for In-Situ Solutions .....	116
Maintenance .....	116
Storage .....	116
Expected Sensor Life .....	116
<b>FDOM Sensor .....</b>	<b>117</b>
About the Sensor .....	117
How It Works.....	117
Potential Interferents .....	118
Fluorescence Wavelengths.....	118
Derived Parameters: FDOM and CDOM Concentration .....	118
Additional Information.....	118
Installation Requirements.....	119

Chemical Incompatibility .....	119
Cleaning .....	119
Recommended Calibration Frequency .....	120
Calibration Procedure .....	120
Checking Calibration Quality .....	121
Shelf Life for In-Situ Solutions .....	121
Maintenance .....	121
Storage .....	121
Expected Sensor Life .....	121
<b>Crude Oil Sensor .....</b>	<b>122</b>
About the Sensor .....	122
How It Works .....	122
Potential Interferents .....	123
Fluorescence Wavelengths.....	123
Derived Parameters: Crude Oil Concentration .....	123
Additional Information.....	123
Installation Requirements.....	124
Chemical Incompatibility .....	124
Cleaning .....	124
Recommended Calibration Frequency.....	125
Calibration Procedure .....	125
Checking Calibration Quality .....	126
Shelf Life for In-Situ Solutions .....	126
Maintenance .....	126
Storage .....	126
Expected Sensor Life .....	126
<b>Rhodamine WT Sensor.....</b>	<b>127</b>
About the Sensor .....	127
How It Works.....	127
Potential Interferents .....	128
Fluorescence Wavelengths.....	128
Rhodamine WT Concentration.....	128
Additional Information.....	128
Installation Requirements.....	129
Chemical Incompatibility .....	129
Cleaning .....	129
Recommended Calibration Frequency.....	130
Calibration Procedure .....	130
Preparing Rhodamine WT Calibration Standard.....	131
Checking Calibration Quality .....	132

Shelf Life for In-Situ Solutions .....	132
Maintenance .....	132
Storage .....	132
Expected Sensor Life .....	132
<b>Fluorescein WT Sensor.....</b>	<b>133</b>
About the Sensor .....	133
How It Works.....	133
Potential Interferents .....	134
Fluorescence Wavelengths.....	134
Fluorescein WT Concentration.....	134
Additional Information.....	134
Installation Requirements.....	135
Chemical Incompatibility .....	135
Cleaning .....	135
Recommended Calibration Frequency.....	136
Calibration Procedure .....	136
Checking Calibration Quality .....	137
Shelf Life for In-Situ Solutions .....	137
Maintenance .....	137
Storage .....	137
Expected Sensor Life .....	137
<b>Service and Repair .....</b>	<b>138</b>
Obtaining Repair Service.....	138
Guidelines for Cleaning Returned Equipment .....	139
<b>Aqua TROLL 600 Instrument Specifications .....</b>	<b>141</b>
<b>Aqua TROLL Sensor Specifications.....</b>	<b>143</b>
<b>More Information.....</b>	<b>144</b>
<b>Declaration of Conformity .....</b>	<b>145</b>
<b>Appendix .....</b>	<b>147</b>
Appendix A: Parameter Numbers and Locations .....	147
Appendix B: Unit IDs.....	150

# Introduction

## Serial Number Location

The instrument serial number is on the product label affixed to the instrument body. Serial numbers for individual sensors are engraved on the sensor body.

## Instrument Description

The Aqua TROLL 600 uses the latest sensor and electronics technology to provide laboratory-quality measurements for field use. Parameters include water level, pH, dissolved oxygen, and more. The instrument fits inside wells as small as 2" in diameter. An optional water level/pressure sensor and a barometric pressure sensor are integrated into the sonde. Additional sensors may be selected and replaced to suit your project's needs. An optional motorized sensor wiper may also be included on the instrument.

Use the Aqua TROLL 600 for long-term monitoring in freshwater and marine environments. It's also ideal for the following applications:

- Groundwater sampling
- Low-flow testing
- Mine water monitoring
- Stormwater management

The built-in LCD screen displays battery status, connectivity info, and other vital information. Setup is easy with the VuSitu app and a Bluetooth-enabled mobile device. The Aqua TROLL 800 records data to internal memory and to a micro SD card simultaneously. It can also work with external PLCs and integrates seamlessly with VuLink telemetry for remote data monitoring.

## Document Conventions

Throughout this document you will see the following symbols:



A checkmark highlights a tip or feature.



The exclamation point calls your attention to a requirement, safety issue, or important action that should not be overlooked.

## Unpacking and Inspecting

Your equipment was carefully inspected before shipping. Check the equipment for any physical damage sustained during shipment. Notify In-Situ and file a claim with the carrier if there is any such damage; do not attempt to deploy or operate the instrument.



Save packing materials for future storage and shipping of your equipment.

Accessories may be shipped separately and should be inspected for physical damage and order fulfillment.

# Safety

## Safety and Damage Warnings



Read the safety information on this page before deploying or configuring your Aqua TROLL 600. If you have questions, contact In-Situ Technical Support for assistance.

- Use D-cell alkaline batteries.
- Do not use the Aqua TROLL 600 in any manner not specified by the manufacturer.
- Do not use batteries of different ages or types.
- Do not submerge the Twist-Lock connector ends of the cable or instrument when they are not connected.
- Do not submerge the Wireless TROLL Com or your mobile device in liquid.
- Ensure that sensors or sensor plugs, are completely inserted into the ports, so that no liquid can enter the instrument.
- Ensure that the RDO Sensor Cap is pressed firmly over the sensor lens and is flush with the instrument before submerging in liquid.
- Replace the cable if insulation or connectors are damaged.
- Make sure the probe and sensor O-rings are clean and free of damage.

## Intended Use

The Aqua TROLL 600 multiparameter sonde is designed to be safe:

- during indoor or outdoor use;
- at altitudes above or below 2000m;
- in ambient temperatures from -5 to 50C;
- in any relative humidity levels;



If the equipment is used in a manner not specified by the manufacturer, the protection provided by the equipment may be impaired.



### Box Contents

1. Documentation and software
2. Wiper motor and brush/wiper
3. Aqua TROLL 600 sonde
4. Water quality sensors (2 of 4)
5. Water quality sensors (2 of 4)
6. RDO sensor cap
7. Accessory supplies
8. pH/ORP sensor maintenance supplies
9. Extra sensors
10. D-cell alkaline batteries
11. Instrument tools

## Getting Started

### 1 Install the batteries.



Open the battery compartment.



Install alkaline batteries.



Use Allen wrench to remove and check desiccant color. If pink, replace.



Close battery compartment. LCD screen should activate.

### 2 Install the wiper motor and sensors.



Remove restrictor.



Apply a pea-sized drop of lubricant to O-rings.



Install wiper motor or port plug into center port.



Apply a pea-sized drop of lubricant to O-rings.

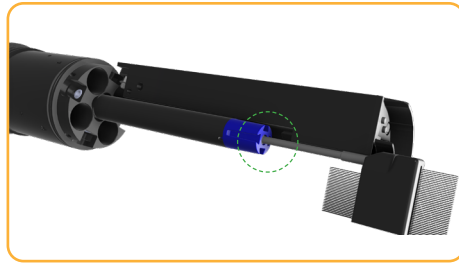

Align sensor with interlock groove in wiper motor and slide sensor into port.

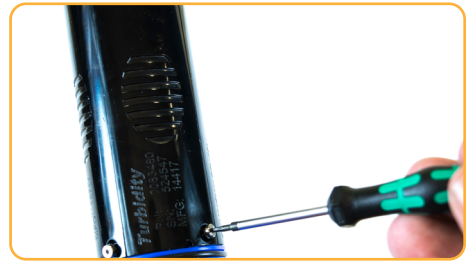

Tighten set-screw at base of each sensor.



Unscrew end cap from restrictor.



Flip restrictor and install with restrictor holes near center of instrument for calibration.



Flip restrictor and replace end cap before deployment.



When using a conductivity sensor and turbidity sensor together, install them side-by-side to maximize performance.

**EFFICIENT**  
SENSOR CONFIGURATION  
- END VIEW -

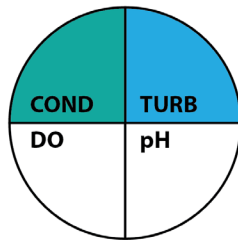

**INEFFICIENT**  
SENSOR CONFIGURATION  
- END VIEW -

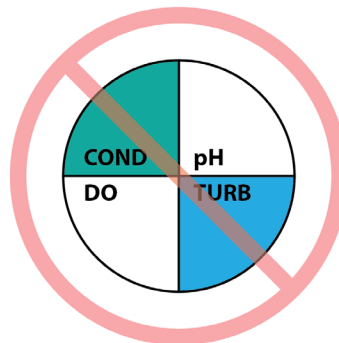

### 3 Connect the cable to the instrument.



Remove protective caps from instrument and cable.



Ensure O-ring on instrument connector is clean. Apply vacuum grease to O-ring.



Flat edge inside cable end must align with flat edge on instrument connector.



Hold textured sleeve of cable in one hand and instrument in other. Push and twist until click.

## 4 Connect the communication device.



If desiccant is present, remove it from cable.



Align TROLL Com connector with cable end. Push and twist until click.

or



Connect VuSitu directly to instrument. Hold sonde vertically with sensors up. Screen will activate.

## 5 Connect to the software.



You must have the VuSitu mobile app to use the instrument with a mobile device. Download VuSitu from the Google Play Store or the Apple App Store.

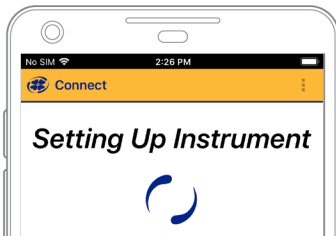

VuSitu automatically connects to the closest In-Situ instrument.

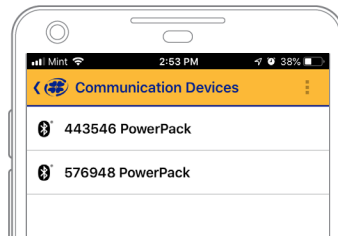

To connect to another instrument, press **Disconnect**. VuSitu displays a list of available connections.



VuSitu's on-screen instructions will guide you through instrument calibration, logging, live readings, and data sharing.

## 6 Learn more.

Get complete instructions about calibration, spot checking, and working with data in the product manual. Download it from [www.in-situ.com](http://www.in-situ.com).

Hereby, In-Situ, Inc. declares the the radio equipment type Aqua TROLL 600 is in compliance with Directive 2014/53/EU. The full text of the EU declaration of conformity is available at the following internet address: [www.in-situ.com](http://www.in-situ.com)

# Required Accessories

## Communication Device

You can use a communication device to calibrate, configure and deploy the Aqua TROLL 600.



### TROLL COM PLUS

Provides power to the Aqua TROLL 600 to extend battery life.

Calibrate, configure, and deploy with a Bluetooth-enabled Android or iOS device.

## Telemetry + Communication Device



### VULINK

Provides power to the the Aqua TROLL 600 in remote-monitoring applications

Calibrate, configure, and deploy with a Bluetooth-enabled Android or iOS device.

Send data to HydroVu or an external FTP Server

---

## Software



### VUSITU MOBILE APP

Calibrate, configure and deploy the Aqua TROLL 600 from a Bluetooth-enabled Android or iOS device.

**Get it from your device's app store.**

# Rugged Twist-Lock Cable

Connects the Aqua TROLL 600 to a TROLL Com or VuLink.

Vented or non-vented.

Stripped and tinned available for connecting to 3rd-party equipment



## RUGGEDCABLE SYSTEM

RuggedCable Systems are custom-built, durable, direct-read cables that include the following items:

- Titanium twist-lock connectors for quick, reliable connections to the instrument, desiccant, and communication cable
- Metal shield beneath the cable jacket to prevent electrical interferences
- Kellems grip for secure instrument deployment
- Small desiccant for vented systems (for storage only)

## VENTED OR NON-VENTED CABLE

Vented cable is used with vented pressure sensors to produce gauged measurements. The cable vent tube ensures that atmospheric pressure is applied to the back of the sensor diaphragm.

Non-vented cable is used with non-vented instruments for absolute measurements. Compensate absolute measurements by using a BaroTROLL Instrument and Baro Merge Software.



Vented cable is shipped with a small desiccant to protect against condensation. Larger desiccants are necessary for deployment.

## JACKET OPTIONS

Tefzel (vented) or thermoplastic polyurethane (TPU, vented or non-vented)

## CUSTOMIZABLE CABLE LENGTHS

Cables can be ordered up to 1,219 m (4,000 ft).

## CABLE TERMINATION

Cables can be ordered with a twist-lock termination (female connector) on both ends that connect to the instrument, the TROLL Com Communication Device, desiccant, and other accessories.

Cables can also be ordered with stripped-and-tinned termination for wiring to a data logger or controller using SDI-12 or Modbus communication protocol.

1	RuggedCable System with female to female connectors
2	Stripped-and-tinned RuggedCable System with female connector
3	Stripped-and-tinned RuggedCable System with male connector (short length that converts a cable with a twist-lock connector to a stripped-and-tinned cable)



## Sensors



### AVAILABLE SENSORS

1. Temperature
2. Conductivity/temperature
3. pH/ORP
4. RDO
5. Turbidity
6. Ammonium
7. Chloride
8. Nitrate
9. Chlorophyll a Fluorescence
10. BGA-PC Fluorescence
11. BGA-PE Fluorescence
12. Rhodamine WT
13. Fluorescein WT
14. FDOM Fluorescence
15. Crude Oil Fluorescence

# System Components

SENSORS	
RDO Sensor - includes RDO-X Cap	0063450
RDO Sensor - includes RDO Fast Cap	0038520
Combination pH/ORP Sensor	0063470
Turbidity Sensor	0063480
Combination Conductivity/Temperature Sensor or standalone Temperature Sensor	0063460, 0063490
Ammonium Sensor	0033700
Nitrate Sensor	0033710
Chloride Sensor	0033720
Chlorophyll A Sensor	0038900
Phycocyanin (BGA-PC) Sensor	0038920
Phycoerythrin (BGA-PE) Sensor	0038930
Rhodamine WT Sensor	0038890
Fluorescein WT Sensor	0096050
Crude Oil Sensor	0096060
Fluorescent Dissolved Organic Matter (FDOM) Sensor	0096070
Sensor Port Plugs (2)	0063510

COMMUNICATIONS	
TROLL Com Plus	0104030
Mobile Device for Android	0064860
TROLL Com RS-232 Cable Connect	0056140
TROLL Com USB Cable Connect	0052500
TROLL Com RS-232 Direct Connect	0056150
TROLL Com USB Direct Connect	0052510

<b>ACCESSORIES</b>	<b>PART NUMBER</b>
Alkaline Batteries (2)	0042020
Dual Titanium Restrictor/Storage Chamber	0079820
Rubber Bumpers (2)	0079880
Wiper or Wiper Port Plug	0063500, 0064630

<b>CABLE</b>	
Stripped-and-tinned Cable with male connector	0053310
Twist-lock Bulkhead Connector	0053240
Twist-lock Backshell/Hanger, Titanium	0051480
Cable Extender	0051490
Large Desiccant (titanium connector)	0051810
Large Desiccant (ABS connector)	0053550
Small Desiccant (3 pack) - storage desiccant	0052230
Desiccant Refill Kit for Large or Outboard Desiccant	0029140

<b>CALIBRATION AND MAINTENANCE</b>	
RDO Classic Cap Replacement Kit	0079790
pH/ORP Replacement Reference Junction Kit	0078990
Wiper Brush Kit	0079810
Maintenance Kit	0078940
Copper Guard	0076100
Quick-Cal Solution for calibrating DO, Cond., pH & ORP	0033250
Dissolved Oxygen Calibration Kit	0032110
D.O. Field Calibration Kit	0080830
Conductivity Calibration Kit (Full)	0032090
Conductivity Calibration Kit (Low)	0032630

Conductivity Calibration Kit (High)	0032640
pH Calibration Kit	0032080
pH/ORP Calibration Kit	0032120
pH Storage Solution	0065370
Individual Calibration Solutions	See website
Ammonium Calibration Kit (includes 1 liter each: 14 ppm, 140 ppm, 1400 ppm, DI water)	0032140
Chloride Calibration Kit (includes 1 liter each: 35.5 ppm, 355 ppm, 3545 ppm, DI water)	0032150
Nitrate Calibration Kit (includes 1 liter each: 14 ppm, 140 ppm, 1400 ppm, DI water)	0032130
Fluorescein WT Solid State RFU Calibrator	0104290
FDOM Solid State RFU Calibrator	0104300
Crude Oil Solid State RFU Calibrator	0104310

<b>LOW-FLOW</b>	
Complete Low-Flow Kit (includes flow cell with fittings and stake, base plate, documentation)	0079790
Flow Cell Kit	0078990
Flow Cell Base Plate	0079810
Fittings Kit	0032130
Pelican Case with Foam Insert	0066860

# LCD Screen



View instrument status and start a basic log via the LCD screen.

## Starting a Basic Log



Use the steps below to start a log when connection to VuSitu is not possible. If no logs are ready to start, a basic log will be created to record all available parameters every 15 minutes.

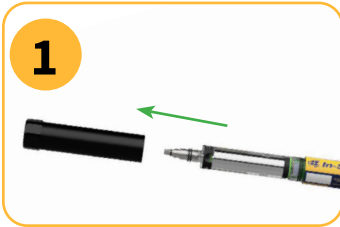

Remove the battery cover.



To create a basic log on the instrument, press the button inside the battery cover 5 times.

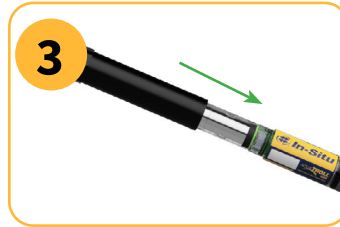

Replace the battery cover.

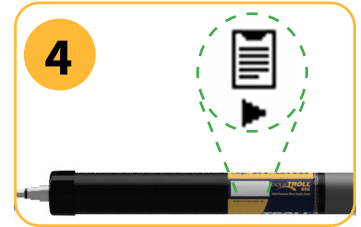

The LCD screen will show that the log has been started.

## Possible Port Statuses



Sensors installed



Port plugs installed



Sensor/port error

## Possible Power Statuses



Battery level indicator



External power provided



Battery below 10% or Battery error

## Possible Log Statuses



Log is Running



Log is Scheduled



Log is Paused



No Log Set Up

## Possible Connected Statuses



Connected via Bluetooth



Connected via cable



Refer to the VuSitu section of this manual for information on Instrument Bluetooth.

## Error Messages



**Install All Sensors!**

Port(s) empty



**RDO Cap expired!**

RDO cap is reaching the end of its expected lifespan.

## FULL-TEXT MESSAGES

The LCD will display text messages instead of status icons when certain conditions are met. The highest priority status will display until it is resolved.

TEXT MESSAGE	CAUSE AND REMEDY
Close battery cover	Battery cover is not fully closed. Ensure the battery cover is securely tightened.
Install wiper	Wiper sensor port is open. Install wiper or wiper port plug into center port.
Install all sensors	Sensor ports are open. Install sensors or sensor port plugs.
Temperature Recommended	No Temperature or Conductivity/Temperature sensor detected. Install a sensor with Temperature.
Install RDO Cap	RDO Cap not detected on RDO sensor. Install RDO cap.
RDO Cap expired	RDO cap is reaching the end of its expected lifespan. Install a new RDO Cap if it is worn or damaged or if sensor is not calibrating properly.
RDO Cap: XXX days remaining	Temporary text message update on the lifespan of the RDO Cap.

## Micro SD Card

The Aqua TROLL 600 uses a micro SD card for data storage. You can remove the SD card and replace it with another for data download, or use the same card. An SD card is not required to log data.

### REMOVING THE MICRO SD CARD

The micro SD card is housed in a slot near the positive battery terminal and the twist-lock connector.

1. Remove the battery cover from the end of the instrument.
2. Push the micro SD card in towards the instrument to release the card.
3. Remove the card from the slot.
4. To reinstall the card, push the card into the slot until you hear a click.

### DOWNLOADING AND DELETING DATA FROM THE MICRO SD CARD

1. Remove card from the sonde and insert it into a micro SD card adapter.
2. Insert the adapter into a PC or laptop.
3. Open the micro SD card using the file explorer.
4. Open the folder titled "Serial Number.LOG." For example, "424690.LOG."



Logs are named by date and then number. For example, a log started on November 12, 2022 would be named "22111200.CSV" - 22 is the year, 11 is the month, 12 is the day, and 00 is the log number. If multiple logs are recorded on the same day the last number will increase by one for each consecutive log.

5. Select the logs you wish to download and move them to the destination.
6. Select the logs you wish to delete and press Delete on the keyboard. Deleted logs cannot be recovered.

ERROR CODE	ERROR DESCRIPTION	RECOMMENDED ACTIONS
UC[0]	User Calibration (UC) Expired	1.) Perform a user calibration on the sensor in a known calibration standard 2.) Follow individual sensor instructions or user SOPs for calibration.
FC[0]	Factory Calibration (FC) Expired	Call (800-446-7488) or contact In-Situ Technical Support (support@in-situ.com). Send the instrument back to In-Situ for factory calibration
OL	Sensor Offline (OL) and no longer communicating with the instrument	1.) Remove sensor and check for water in the connection port. Dry sensor and sonde connector. Reinstall sensors. 2.) Remove two sensors and reinstall in separate port. 3.) Call (800-446-7488) or contact In-Situ Technical Support (support@in-situ.com).
WU[0]	Wiper Error - wiper is not turning correctly or interfering with sensor performance	1.) Inspect wiper to ensure surface is free of debris and the wiper is spinning correctly. 2.) Remove wiper brush and install a new brush holder with new brushes. 3.) Remove the wiper and check for water in the connection port. Dry the wiper port and the sonde connector. Reinstall wiper. 3.) Call (800-446-7488) or contact In-Situ Technical Support (support@in-situ.com).
ERR[0]	Sensor is performing outside of expected range	1.) Make sure the sensor is submerged in solution. 2.) Recalibrate sensor in a fresh batch of calibration standard. 3.) Reset sensor back to factory defaults and check reading in a calibration standard. Recalibrate. 4.) Call (800-446-7488) or contact In-Situ Technical Support (support@in-situ.com).
DIS[0]	Sensor is not set up correctly, being used outside of temperature or sensor range or returning a sentinel value due to internal malfunction or damage	1.) Verify that the RDO sensor cap is installed, the sensing foil is intact and the cap has not expired. 2.) Clean the surface of the sensor to remove any excess debris 3.) Verify that the instrument and sensors are not being used outside of temperature or sensor specifications. 4.) Verify that the sensor is not physically damaged 5.) Call (800-446-7488) or contact In-Situ Technical Support (support@in-situ.com).

# Calibrating Sensors

## Calibration in VuSitu



The VuSitu mobile app provides guided instructions for calibration. See the sensor sections of this manual for detailed calibration instructions, additional parameter settings, and troubleshooting help specific to each sensor.

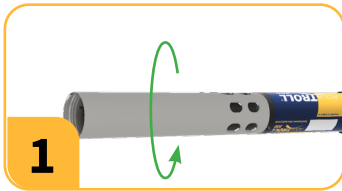

**1** Place the restrictor in calibration mode (holes near the center of the instrument).

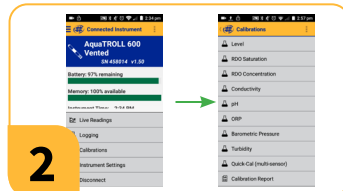

**2** Choose Calibrations in VuSitu. Select a calibration to perform.



**3** Follow the on-screen instructions to prepare the calibration. See the sensor sections of this manual for more detailed information.



**4** Start the calibration. A Calibration Report will be generated for your records after calibration is complete.

## Calibrating with a Copper Restrictor



When using a copper restrictor, do not flip the restrictor into calibration mode. Instead, follow the steps below for accurate calibration results.



**1** Leave the restrictor in deployment mode. Slide the calibration sleeve over the holes.



**2** Calibration sleeve is ready when it is fully seated on the end of the restrictor.



**3** Continue the rest of the calibration as described above.

## Factory Calibration

Factory calibration includes a thorough cleaning, full functionality check and sensor adjustments to all applicable sensors over the entire calibrated temperature range. We recommend a factory calibration every 12 months or when the unit appears to drift significantly.

# Batch Calibrating Sensors in VuSitu

## Multiple Sensors of the Same Type



For some parameters, you can calibrate multiple sensors of the same type together. Use this feature when you need to batch calibrate a group of sensors prior to field deployment.



1

Install the sensors to calibrate. (pH/ORP sensors also require a temperature sensor.) Install the restrictor in calibration mode.

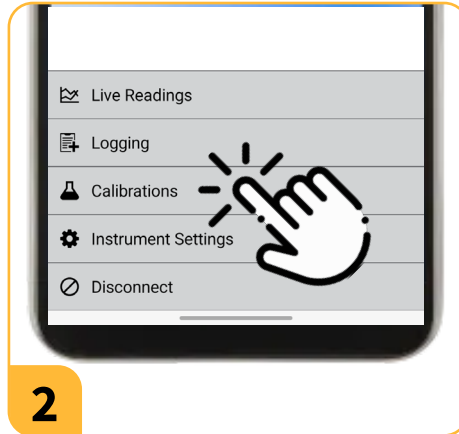

2

In VuSitu, click **Calibrations** from the Connected Instrument screen. Choose a calibration to perform.



3

Set up the calibration. Make sure that all sensors are completely submerged or in the same calibration environment.

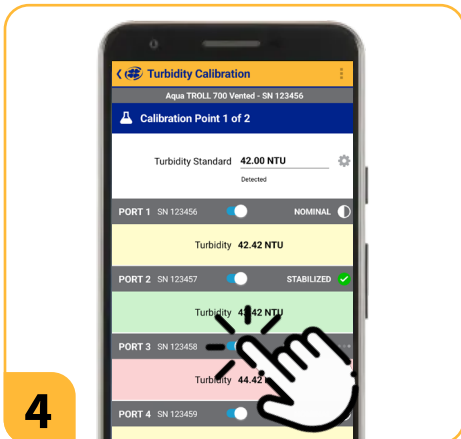

4

Wait for calibrations to complete. If one sensor isn't stabilizing, use the toggle switch to turn that sensor off and continue calibrating the others.

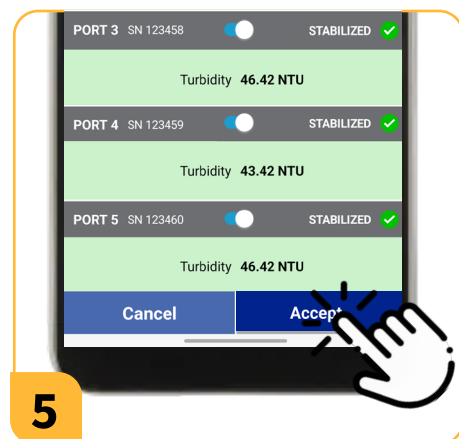

5

When all sensors have stabilized, tap **Accept**. Review the calibration report for the completed sensors.



6

Remove sensors and install them in the instruments they will be deployed in.



You may see variations in readings between sensors during or after calibration. Sensors are performing properly if they are within the published accuracy range for the sensor type.

## Different Sensor Types (Quick Cal Solution)



Use Quick Cal standard to calibrate conductivity, pH, and ORP with a single solution. Quick Cal solution can also be used for 100% RDO Saturation calibration. To calibrate multiple sensors of the same type, follow the instructions on the next page.



1 Install the restrictor in calibration mode (with holes closest to the instrument body).



2 In VuSitu, click **Calibrations** from the Connected Instrument screen. Choose **Quick Cal** from the menu.

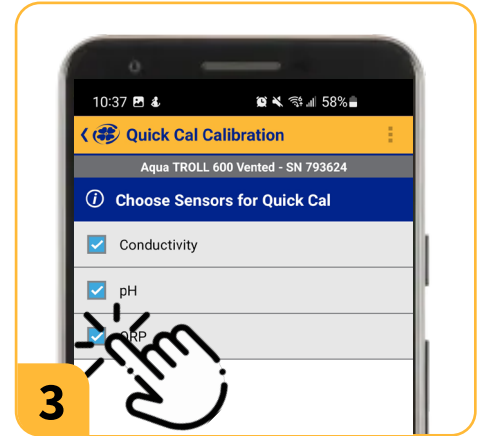

3 Select sensors to calibrate.



4 Set up the calibration. Make sure that all sensors are completely submerged.



5 When all sensors have stabilized, tap **Accept**. Review the calibration report for the completed sensors.



6 Flip the restrictor back into deployment mode and install the end cap.

# Reported Depth

If a pressure sensor is included, Aqua TROLL 600 uses its pressure reading and specific gravity value to calculate depth. The pressure sensor is located at the center of the instrument, but depth is reported at the smart sensor faces. An embedded gyroscope compensates for the distance between these sensors and allows the sonde to be deployed in any orientation (vertical, horizontal, angled).

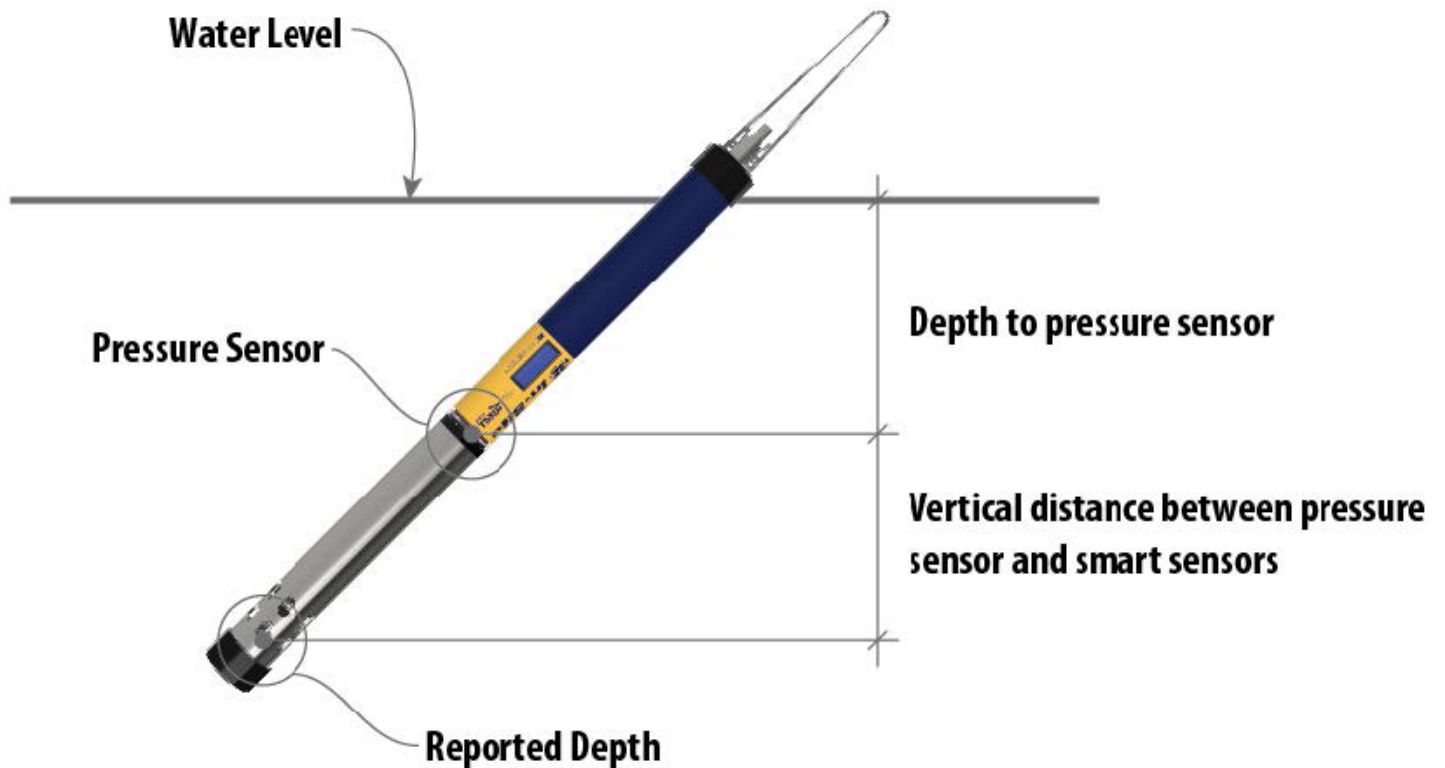

# Navigating VuSitu

## Connecting to VuSitu



Use VuSitu to calibrate, configure, and deploy your Aqua TROLL 600. Download the app for free from the Google Play Store or the Apple App Store.

### Connecting with Bluetooth

The Aqua TROLL 600 can connect to a Bluetooth-enabled device for wireless communication with the VuSitu mobile app.

- If the Aqua TROLL 600 is connected to a Wireless TROLL Com, press the button on the Wireless TROLL Com. Then open VuSitu to connect.
- To connect to the Aqua TROLL 600 directly, turn on the Aqua TROLL 600 LCD screen by holding the sonde vertical with the sensor end facing up. Then open VuSitu to connect.

## Connected Instrument Screen

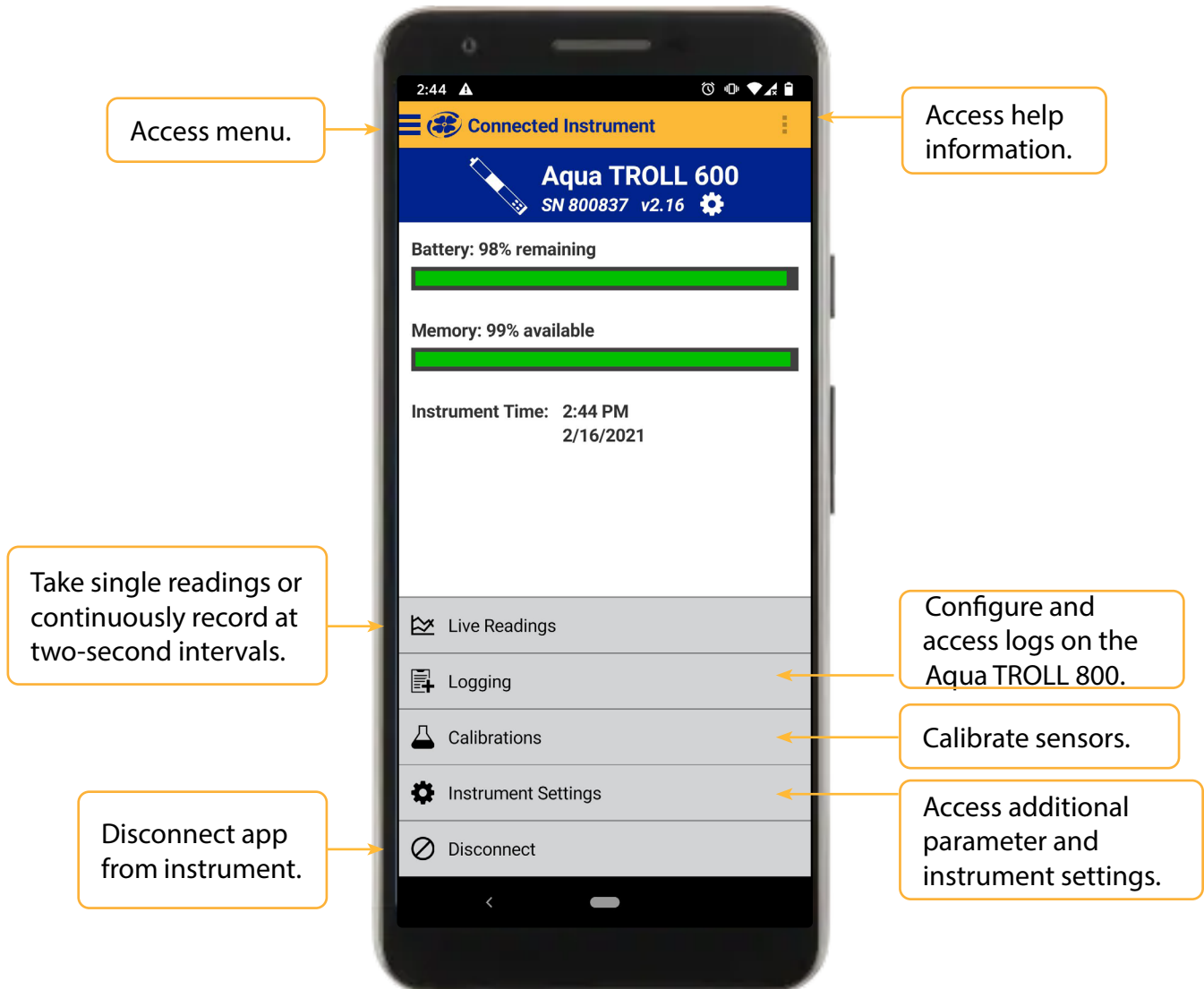

# Logging in With HydroVu

You can log in with HydroVu when you first connect to VuSitu, or any time from the Log In & Connect page. As you work, any new data files you save will automatically upload to your HydroVu account when you have an internet connection so you can easily transfer and manage your data:

- Logs
- Live Readings
- Daily Snapshots
- Calibration Reports
- Low-Flow Tests



View, download, and manage your data at [www.hydrovu.com](http://www.hydrovu.com).

## Data files upload automatically as you work:

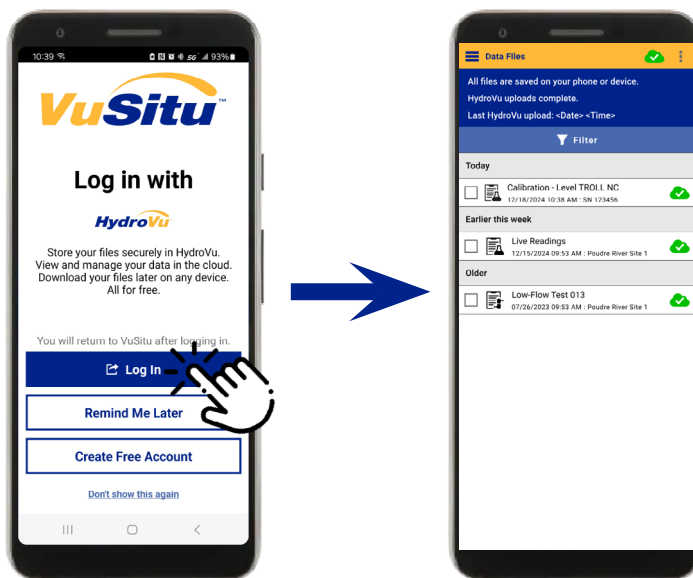

## View and manage all of your data in HydroVu, from any device:

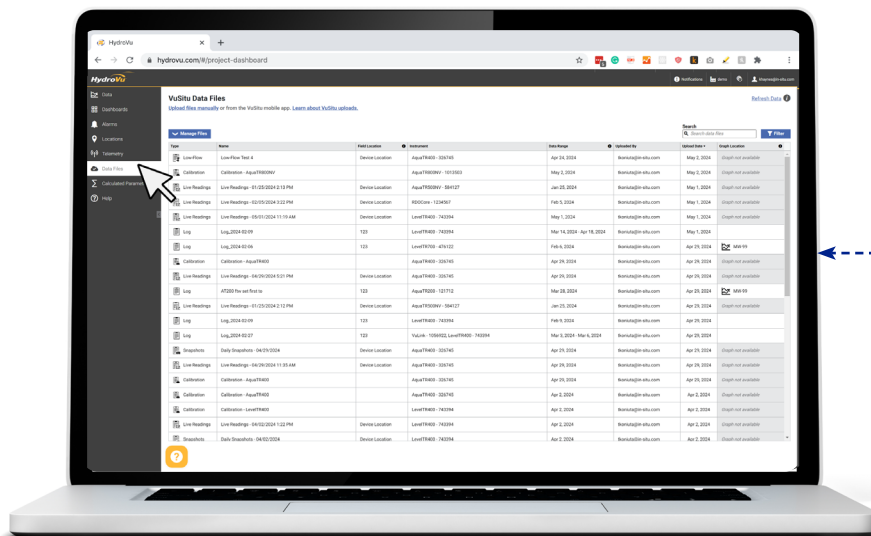

## VuSitu Menu Options



The features available in the VuSitu mobile app vary slightly depending on the instrument to which it is connected.

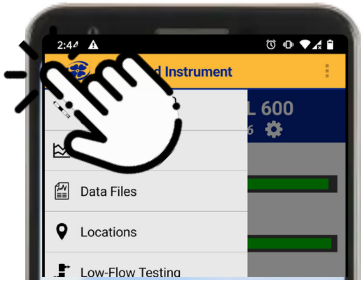

Tap the menu icon in the upper left portion of the screen to view options. Tap the icon again to close.

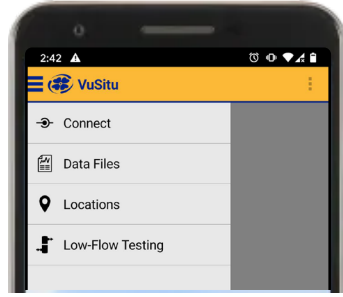

Some features aren't available when VuSitu isn't connected to an instrument.

## Selecting with Long-press and Swipe



Press and hold any item in a list of files. You can now select multiple files.

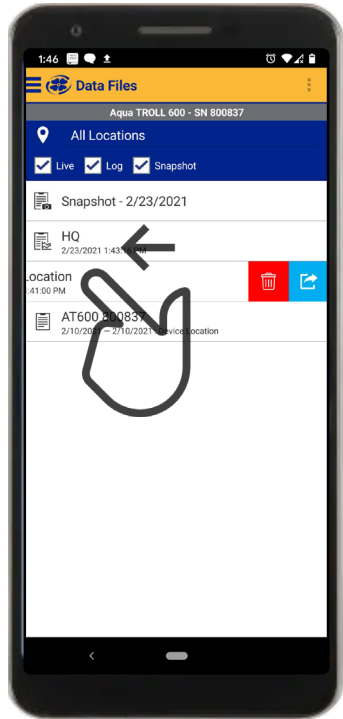

Press and swipe left to reveal the delete and share icons.

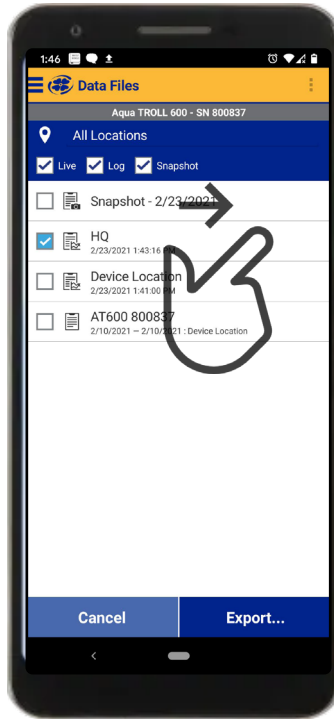

Press and swipe right to reveal the sharing icon.

# Live Readings in VuSitu



The live readings screen displays measurements taken from the instrument every two seconds. You can save these readings to a data file which will automatically be uploaded to HydroVu if you are logged in.

## Snapshot Mode

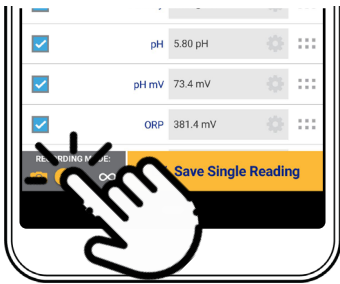

Tap the button on the bottom left to toggle between snapshot and live readings modes.

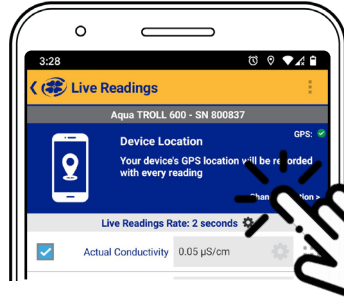

Tap **Change Location** in the top right corner if you wish to associate this data with a different location.

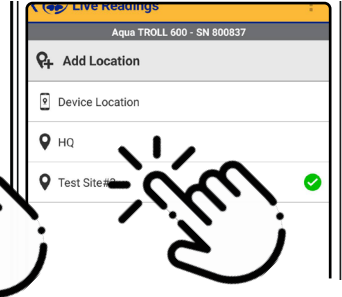

Choose the desired location and press **Save** in the bottom right corner of the screen.

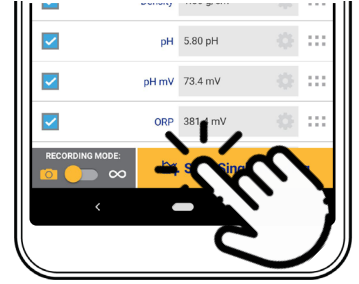

Tap **Save Single Reading** to create a snapshot.

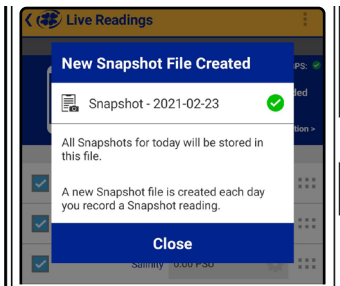

VuSitu confirms the new snapshot file.

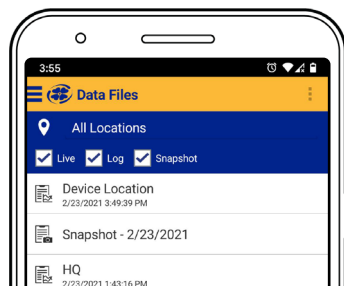

View the file from the Data Files screen.

## Live Readings Mode

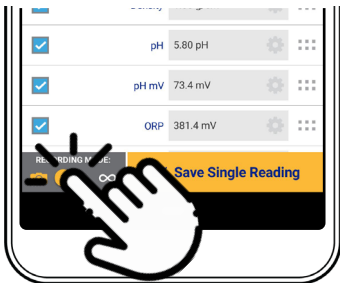

Tap the button on the bottom left to switch from snapshot mode to live readings mode.



Tap **Start Recording**. The instrument takes a reading every two seconds.

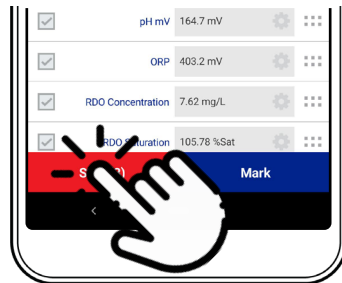

Tap **Stop** to end the recording. VuSitu displays a summary of the live readings data.

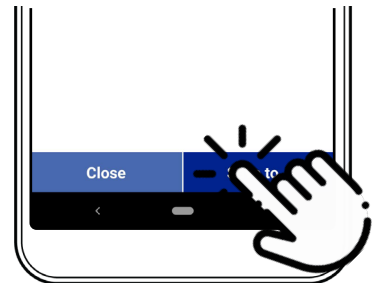

Tap **Save to** if you wish to share the Live Readings file via email or cloud storage.

# VuSitu Locations

## About VuSitu Locations

A VuSitu location represents the physical spot where an instrument collects data. You can create a VuSitu location for any monitoring site. If you don't create a location, your data defaults to "Device Location." Location names appear on the live readings screen, in snapshot files, and in log files.

## How to Create a Location

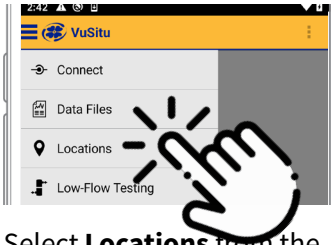

Select **Locations** from the main menu.

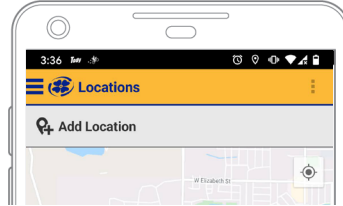

Tap **Add Location**.



To home in on your mobile device's current location, tap the button on the top right.

Tap the pin icon to establish the location on the map.



As an alternative, you can manually enter latitude and longitude values and tap **Apply**. Or, tap and hold a specific point on the map to drop a pin there.

## How to Edit or Delete a Location

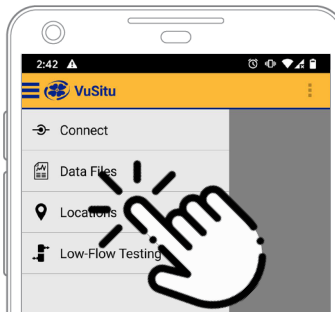

Select **Locations** from the app menu.

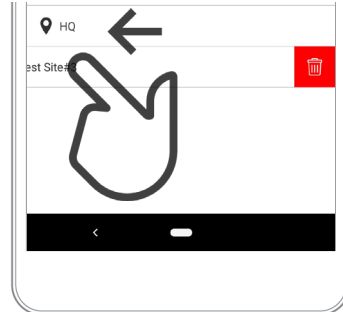

Tap the location you wish to delete and swipe left. Tap the trash icon.

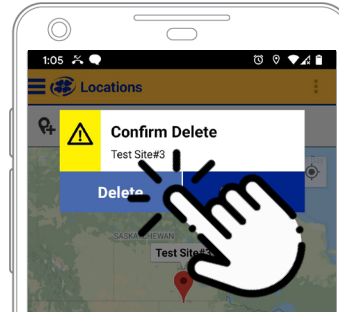

Confirm by tapping **Delete**.

## How to Select a Location



Data is associated with the Location that is displayed on the Live readings screen. After you have created a Location, you must select it in order for your data to be associated with the Location.

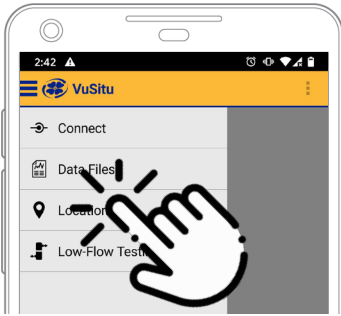

Select **Locations** from the app menu.

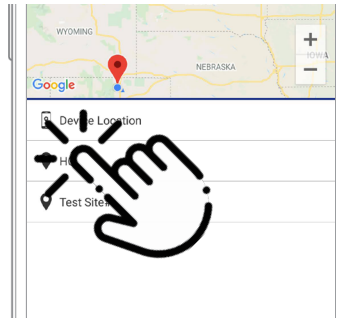

Tap a location to select it.

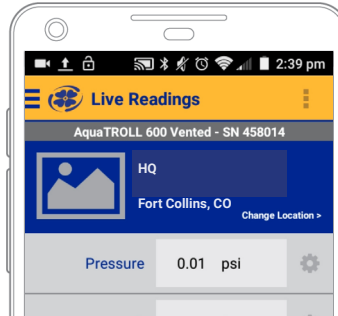

New live readings data will be associated with this location until you select another.

## Wiper Interval Settings



You can choose how often the wiper cleans the sensor faces from Wiper Settings in the Instrument Settings menu. For the highest cleaning performance, set the wiper to clean with every reading. The wiper will not spin faster than the current reading interval.

## Instrument Bluetooth

### Disabling Instrument Bluetooth



You can use Instrument Bluetooth to connect directly to the Aqua TROLL without a communication device. Instrument Bluetooth is enabled by default on your Aqua TROLL 600. If you need to disable Instrument Bluetooth, follow the steps below.



Connect to VuSitu using a Wireless TROLL Com or a VuLink.



Select **Instrument Settings**.

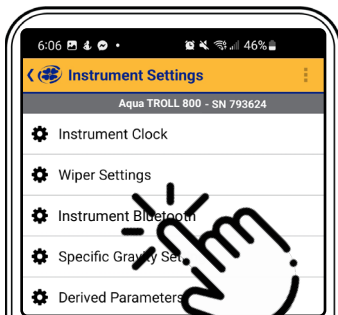

Select **Instrument Bluetooth**.

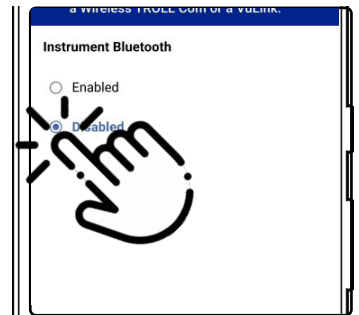

Choose **Disabled**, then save your selection.

# Logging

## Creating a Log with VuSitu



Connect to the instrument via VuSitu to create a log. Then follow the on-screen instructions. You can schedule a start time for the log or start the log immediately.

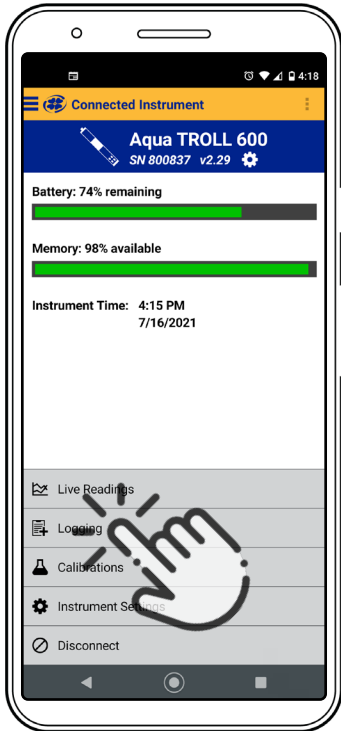

Select **Logging**.

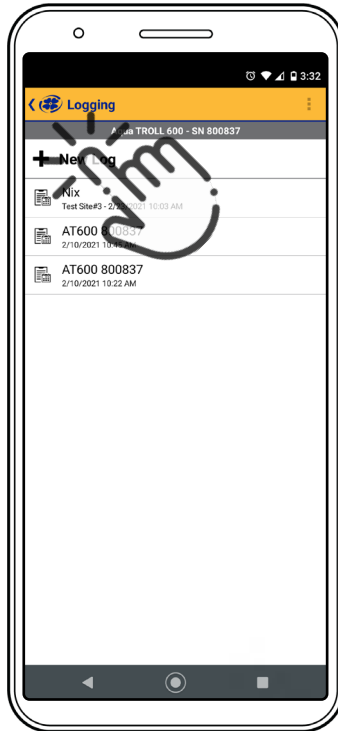

Tap **New Log**.

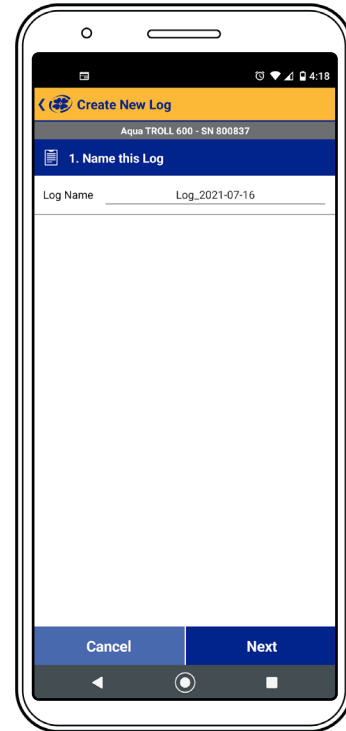

Follow the on-screen instructions to create and schedule a log.

## Downloading and Managing Data



Download a data log to save it from the instrument to your VuSitu data files. If you are logged in, data files will automatically be uploaded to HydroVu. You can access these files from any device and barometrically compensate non-vented data at [www.hydrovu.com](http://www.hydrovu.com). For help and tutorials, visit [www.help.hydrovu.com](http://www.help.hydrovu.com).

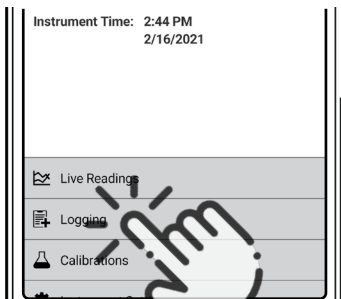

Pair VuSitu with the instrument. Select **Logging** from the Connected Instrument screen.

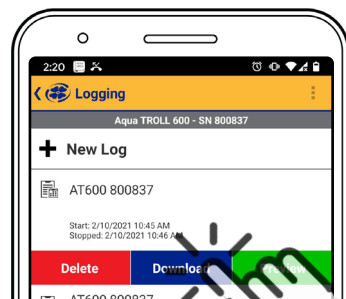

Tap a log and press the **Download** button.

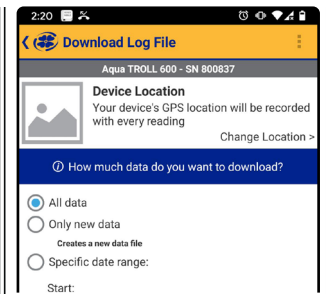

Choose the data you wish to download from the instrument. To save the entire log, choose **All data**.

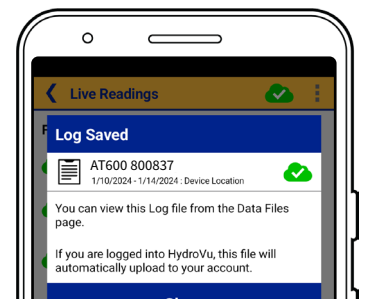

When the download is complete, the log is saved in your VuSitu data files.

# Remote Monitoring with VuLink



Using VuLink in any manner not specified by the manufacturer may impair the device's built-in protections. For complete information on remote monitoring, refer to the VuLink manual at [www.in-situ.com](http://www.in-situ.com)

## 1 Claim VuLink.

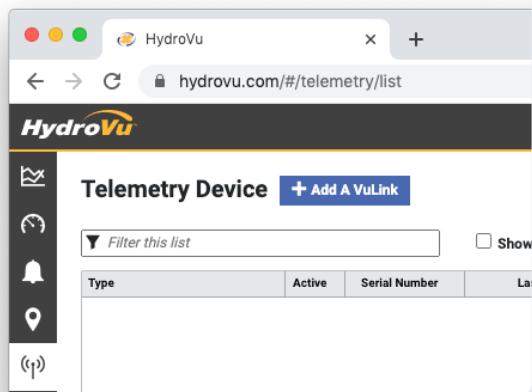

Log into your HydroVu account and claim VuLink from the Telemetry page.

## 3 Configure and deploy.

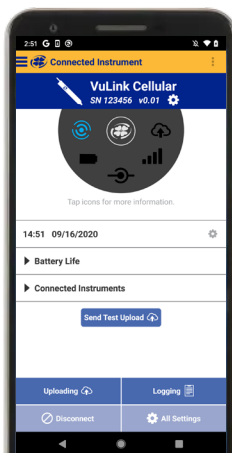

Create a log and adjust instrument settings with the VuSitu mobile app. Then deploy the instrument.

## 2 Connect the instrument.

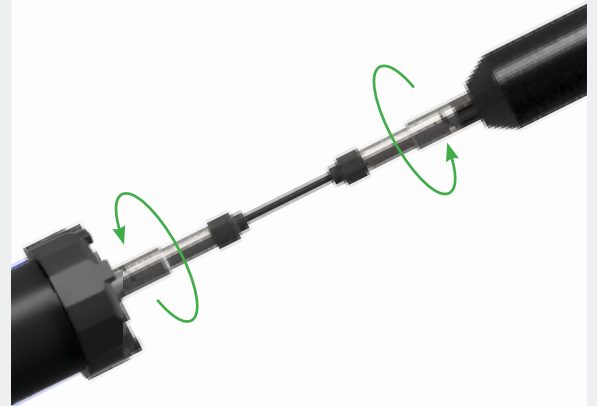

Connect the Aqua TROLL instrument to VuLink with a Rugged Twist-Lock Cable.

## 4 View data in HydroVu.

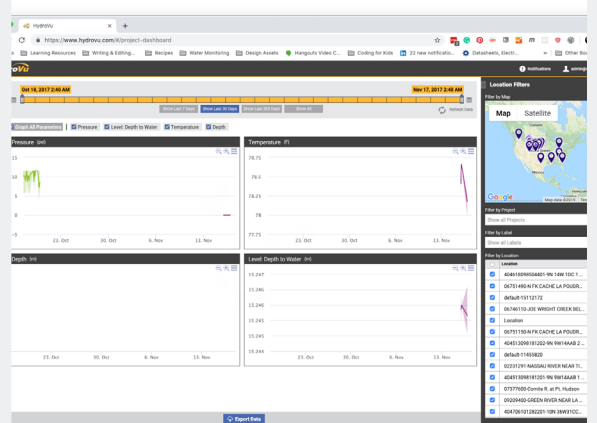

See graphs of your data and make changes to VuLink in HydroVu.



# HydroVu



HydroVu is a data-management application that runs in the browser. Use it to manage data, view graphs, and configure telemetry devices for remote monitoring. See it at [www.hydrovu.com](http://www.hydrovu.com).

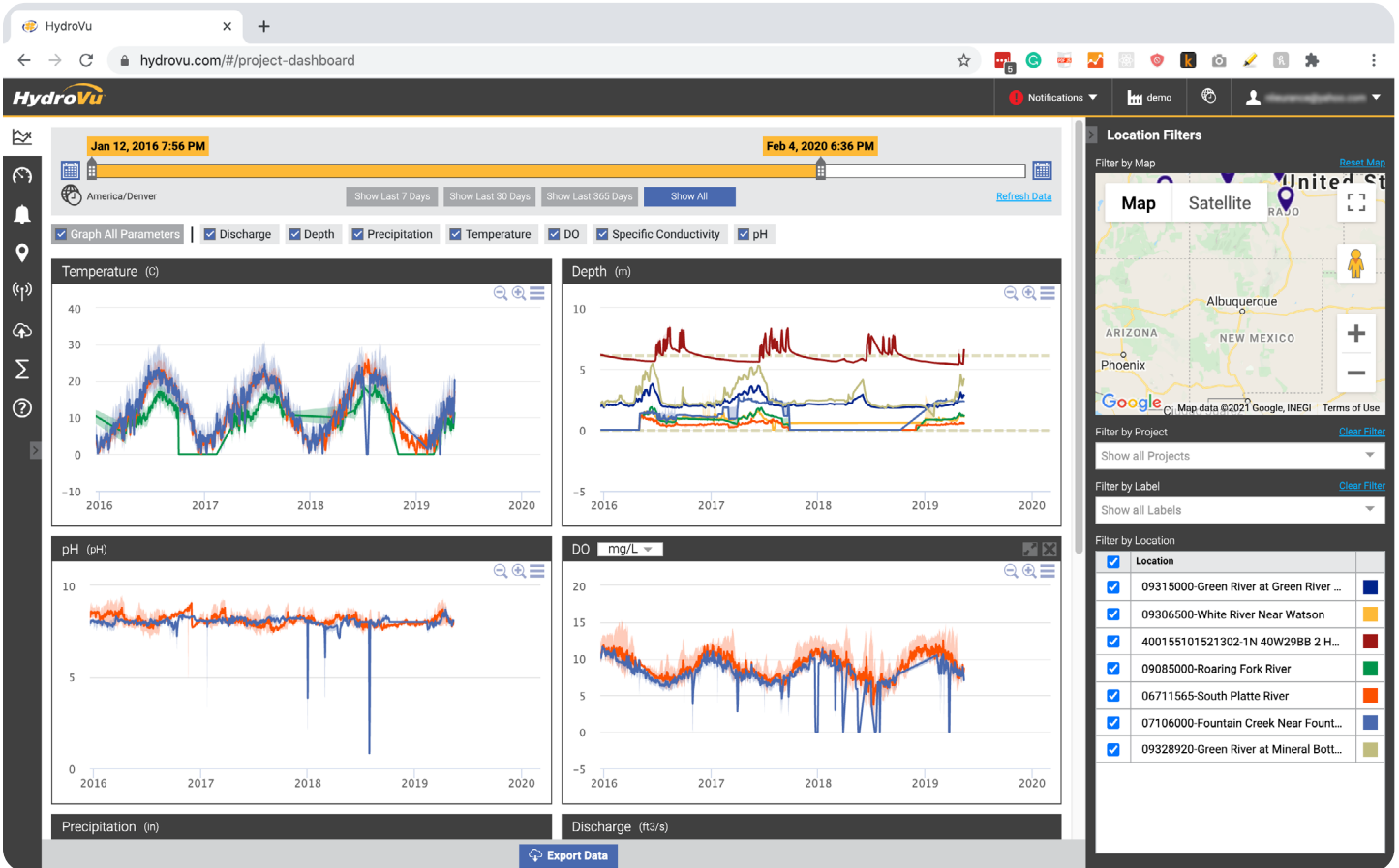

To learn more about how to use HydroVu, visit the HydroVu Help Center at <https://help.hydrovu.com/>.

# Connecting to a PLC or Data Logger

## Flying Leads Wire Diagram



Refer to the diagrams on the following pages for PLC wiring diagrams. Unused leads should not be touching.



Current from an external power source must not exceed 4 amps.

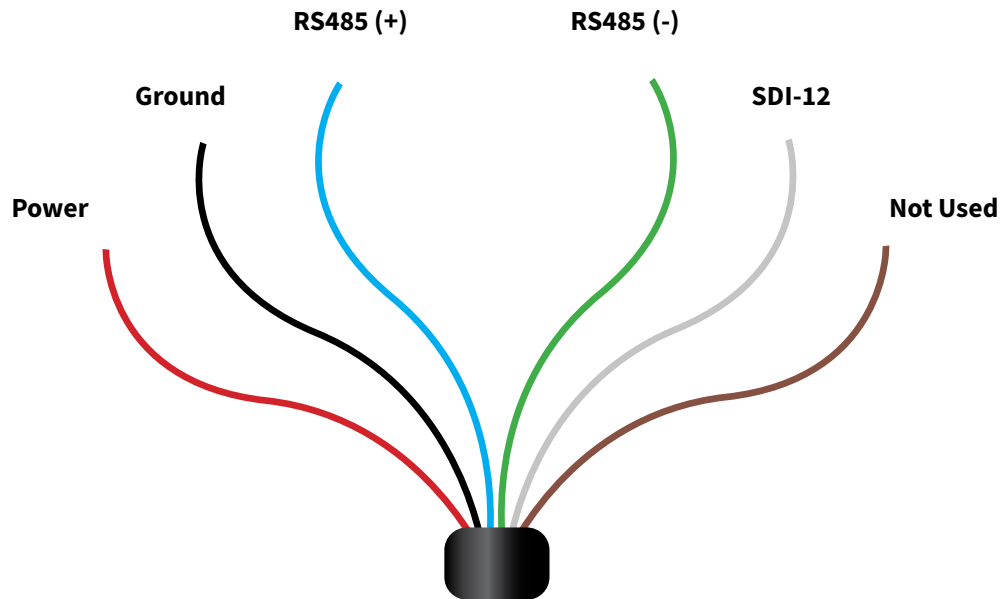

WIRE COLOR	SIGNAL
Red	External Power
Black	Ground
Blue	RS485 (+)
Green	RS485 (-)
White	SDI-12
Brown	Not Used

### Desiccant

Vented cable must be installed with outboard desiccant to protect the cable vent tube and Aqua TROLL electronics from condensation in high-humidity environments.

The desiccant is replaceable and may be temporarily removed from the vent tube during installation.

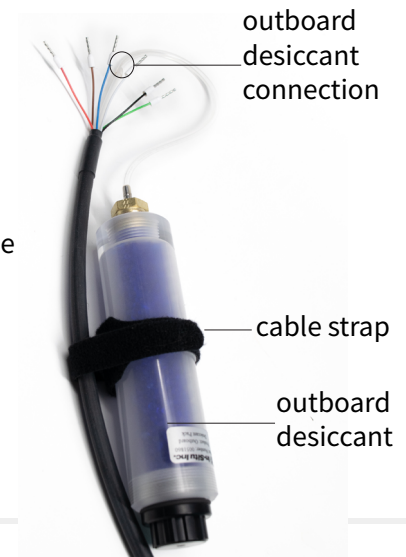

# SDI-12 wiring diagram

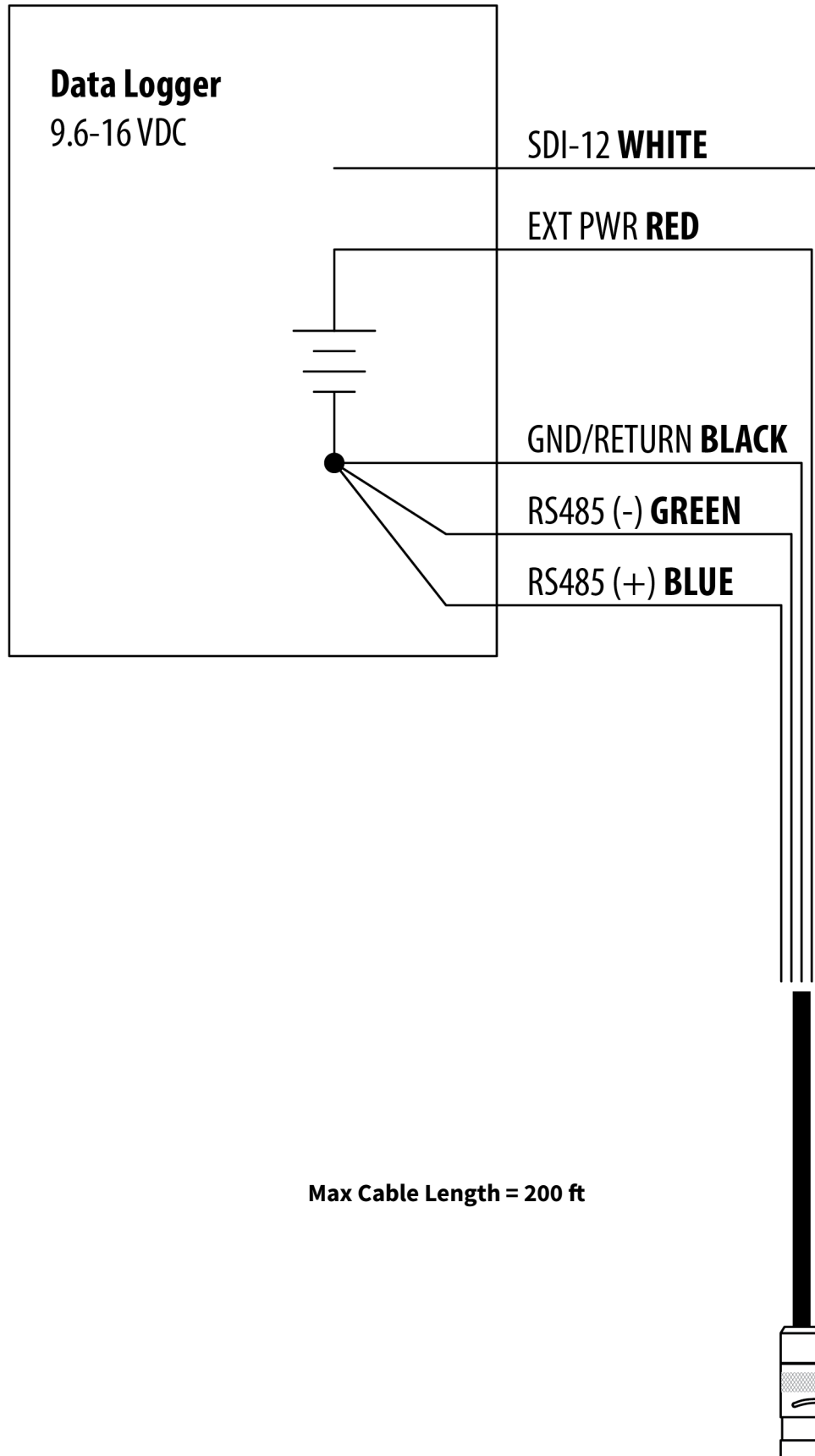

## Modbus (RS485) wiring diagram

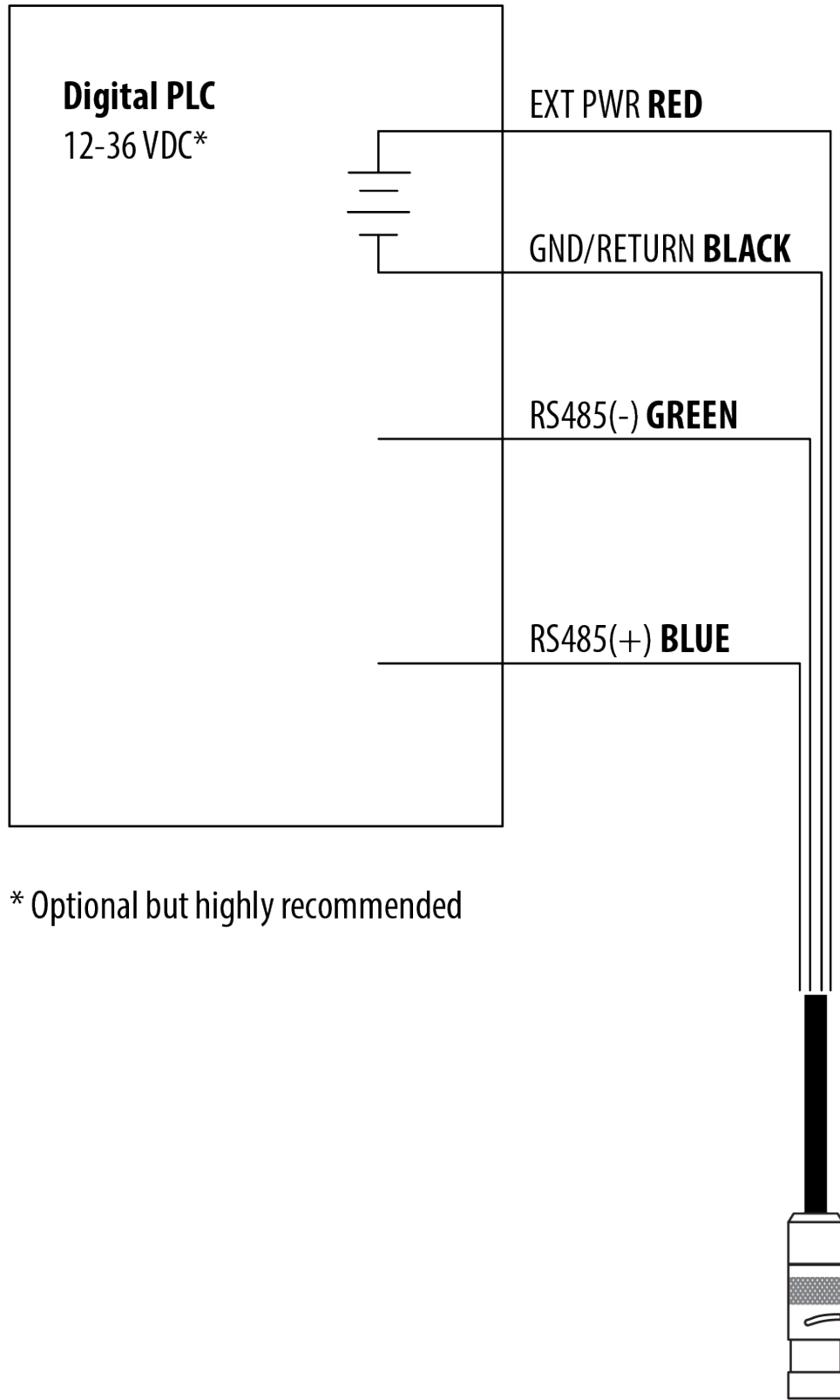

\* Optional but highly recommended

# Modbus (RS232 with converter) wiring diagram

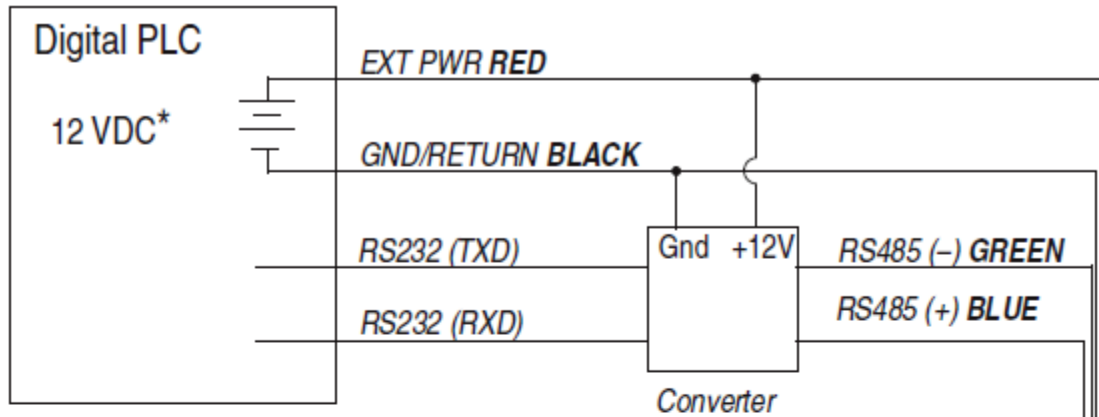

\* Voltage limited by converter

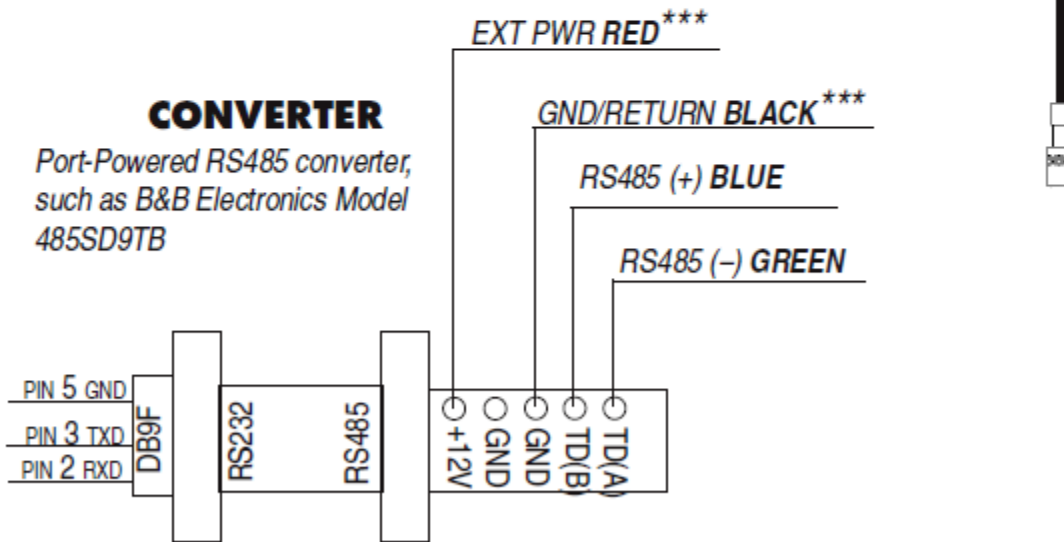

\*\*\*Required if port power is not available

# Configuring SDI-12 Settings

## About SDI-12

You can configure the list of SDI-12 parameters in VuSitu under **Instrument Settings**.

The Aqua TROLL 600 conforms to the general SDI-12 Standard Version 1.3. For more information about SDI-12 commands, see the SDI-12 Standard Version 1.3 document from the SDI-12 Support Group Technical Committee.

## Configure SDI-12 Settings in VuSitu

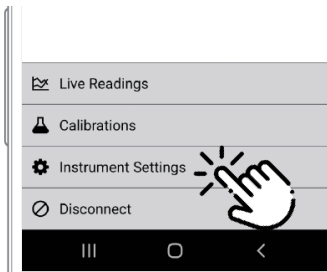

Connect to VuSitu and select **Instrument Settings**.

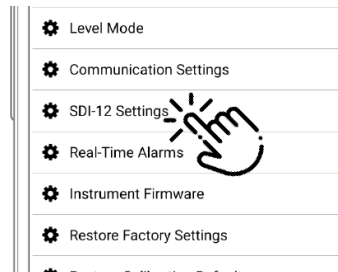

Choose **SDI-12 Settings**.

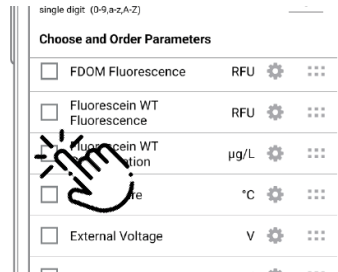

Use the checkboxes to select parameters to display.

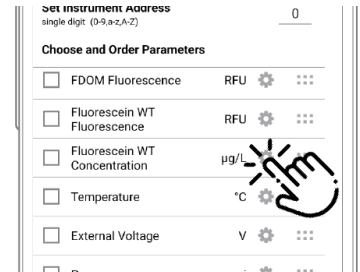

Tap the gear icon to adjust the units for each parameter.

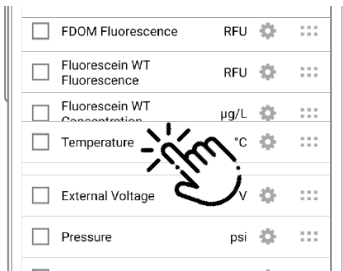

Drag and drop parameters to change the order.

# Modbus PLC Interface

## Overview

The Modbus PLC Interface is a simplified method of communicating with the Aqua TROLL 600 using the Modbus protocol. It reduces programming complexity and allows the user to remove sensors and reinstall them in different ports. Please observe the following limitations when using this interface:

- Only one sensor of any sensor model can be used in the sonde (for example: only one turbidity sensor can be installed).
- If a parameter is provided by more than one of the installed sensors, the interface will return the first value available.
- Firmware version 1.01 or later must be installed on the sonde.

For information about the specific Modbus registers and Unit IDs for your Aqua TROLL 600, see Appendices A and B. The Aqua TROLL 600 conforms to the Modbus standard. For more information about Modbus communication, see [www.modbus.org](http://www.modbus.org).

## Setting Up Instrument

1. Install the sensors and turn on the display by holding the instrument vertically.
  - a. Ensure the display turns on and check the LCD to ensure the sensors are working.
2. The setup below is using the instrument's factory default settings. Use VuSitu to reset the instrument to factory defaults if they have been changed. Take note of any changes in default units setup.

## Programming the PLC

1. Set up the serial communication to match the instrument communication settings. Communication settings can be changed with the VuSitu mobile app. The default communication settings are:

MODE	START BIT	BAUD RATE	DATA BITS	PARITY	STOP BIT
RTU	1	19200	8	Even	1

2. Set the device address match the instrument address. The default device address is 1.
3. Set the PLC to wake-up the device by sending a carriage return (0x0D) or any Modbus command.
  - a. Allow one second before sending a second command. The instrument needs this time to wake up.
  - b. After the wake-up command, the next reading must be taken before the end of session timeout. If the reading interval exceeds the end of session timeout, send a new wake-up command before requesting a new reading. The default end of session timeout is 5 seconds, and may be longer if the instrument has been connected to VuSitu.
4. If you have changed or moved the sensors since the device was last connected, read holding register 46948 to trigger the instrument to scan the sensors. The return value can be discarded.
  - a. Each register is a holding register. If your PLC requires a register address, subtract 40001 from the holding register number.
  - b. Alternatively, you can prompt the instrument to discover its sensor mapping by connecting it to the VuSitu mobile app.
5. Select the register to read on the PLC using the information in the following sections.
  - a. If your PLC requires a register address, subtract 40001 from the holding register number. For example: Holding Register Number 45451 corresponds to Register Address 5450.
6. Set the type of register to: 32-bit float
  - a. If asked by the PLC this is 2 registers
7. Set the byte order to: Big Endian (MSB)
  - a. This should be the default and may not be configurable on all PLCs

## Reading Device Information

Use the following registers to read general information about the instrument.

HOLDING REGISTER NUMBER	HOLDING REGISTER ADDRESS	SIZE (REGISTERS)	DATA TYPE	DESCRIPTION
49001	9000	1	uint16	Device ID: 7 = Aqua TROLL 600 Non-Vented 26 = Aqua TROLL 600 Vented
49002	9001	2	uint32	Serial Number
49007	9006	1	uint16	Firmware version (100 = 1.00)

## Reading Parameters

Each parameter contains a block of 7 registers as shown in the table below. To read measurements for a specific parameter, look up the starting register for that parameter from the list of Parameter Numbers and Locations in Appendix A. Once you have the starting register, add the number of offset registers for additional information about the reading.

REGISTER OFFSET	SIZE (REGISTERS)	MODE (R/W)	DATA TYPE	DESCRIPTION
0	2	R	float	The measured value from sensor
2	1	R	uint16	Data Quality ID: 0 = No errors or warnings 3 = Error reading parameter 5 = RDO Cap expired For additional errors or information, contact technical support.
3	1	R/W	uint16	Units ID for this parameter. See: Appendix B.
4	1	R	uint16	Parameter ID for this parameter. See: Appendix A.
5	2	R/W	float	Off line sentinel value: The value that's returned on error or if the parameter isn't available. The default sentinel is 0.0

For example, you can apply this information to collect a reading for Actual Conductivity.

From the list in Appendix A, you can find that the starting register for Actual Conductivity is 45507. A reading from register number 45507 (register address 5506) will return the measured value of Actual Conductivity.

Some PLC devices use the register number directly in programming statements, others use register addresses. Refer to PLC manufacturer instructions to determine which programming style to use.

You can use the register offsets listed in the table above to collect additional information about the reading. Adding the register offset of 2 to the starting register, you can find that register number 45509 (register address 5508) will return the Data Quality ID for the most recent Actual Conductivity measurement. Likewise, register number 45510 (register address 5509) will return the Units ID, which can be interpreted from Appendix B. Register number 45511 (register address 5510) will return the Parameter ID, which can be interpreted from Appendix A. Register number 45512 (register address 5511) will return the sentinel value.

The Units ID and Sentinel Value are writeable registers. Measurements can be changed to other units using the Units ID as shown in Appendix B. For example, if register number 45510 (Actual Conductivity Units ID) returns 65, Actual Conductivity is configured to report in  $\mu\text{S}/\text{cm}$ . Looking at Appendix B, you can find that  $\text{mS}/\text{cm}$  is also a valid unit which can be set by writing Units ID 66 to register number 45510.

## Turning on Instrument Bluetooth with a PLC

Use the VuSitu mobile app to configure, calibrate, and troubleshoot the instrument. To enable Bluetooth from a PLC:

1. Stop sending logging or data commands from the PLC or data logger.
2. Write "1" to register number 49211 (register address 9210) to enable Instrument Bluetooth.
3. Set the instrument on a flat surface and stop sending commands for 1 minute.
4. Turn instrument vertical to activate the changes, then connect to VuSitu.

# Care and Maintenance

## Storage

### SHORT-TERM (LESS THAN ONE WEEK)



Remove the restrictor and the end cap.



Put the restrictor on the instrument in calibration mode.



Pour 15 mL (0.5 oz) of clean water into the restrictor and replace the cap.



Thread the restrictor onto the sonde and store.

### LONG-TERM (MORE THAN ONE WEEK)



Remove pH/ORP and any ISE sensors.



Dampen the sponge inside the pH sensor storage cap with Storage Solution or pH 4 calibration standard.



Replace the caps at both ends of the sensor. Use electrical tape to seal the storage cap.



Thread the restrictor onto the sonde.



Store the sonde between  $-40$  and  $65^{\circ}$  C. See the sensors section for additional storage requirements for pH/ORP and ISE sensors.

## Cleaning the Sonde

Rinse the sonde thoroughly. Clean with warm water and mild soap, then rinse the sonde again. Air dry.



Prevent water from entering the cable connector.

## Removing the Restrictor

If the restrictor or end cap are stuck and difficult to remove by hand, use strap wrenches to provide extra leverage. Remove the end cap bumper before using strap wrenches.



Never use pipe wrenches or a vise grip which may damage the instrument. Never insert tools into the restrictor holes for leverage, as they may damage the wiper shaft or sensors. Strap wrenches should only be used when necessary to remove or loosen parts. Tighten parts by hand only.

## Cleaning the Copper Restrictor

When copper is deployed in environmental waters, particularly marine environments, the copper will oxidize and develop a patina, which may affect optical sensor readings. Gently remove biofilm with a cloth or soft bristle brush, mild soap, and warm water. Avoid soaking the restrictor in solvents or acids so that the natural patina is preserved and calibrations are representative of field conditions.

# Factory Maintenance Schedule



For best results, send the instrument and sensors for factory maintenance and calibration every 12 to 18 months.

## User-Serviceable Parts



### O-RINGS

Lubricate O-rings during initial setup. Check and replace O-rings if worn, damaged, or discolored.



### WIPER BRUSH

Replace brush according to site needs when bristles are visibly bent, damaged, or fouled.



### DESICCANT CAPSULE

Replace the desiccant capsule when the desiccant turns pink.



### BUMPERS

Replace bumpers and collar when they are visibly worn or damaged.



### SENSORS

See each sensor instruction sheets for details about maintaining and replacing each sensor.

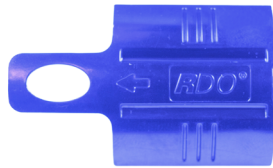

### RDO SENSOR CAP

Refer to the sensor cap instruction sheet for details.



### SENSOR FILL SOLUTION

Refer to the instructions for the pH/ORP sensor and ISE sensors like Nitrate, Ammonium, and Chloride for details.



### REFERENCE JUNCTION

Refer to the instructions for the pH/ORP sensor and ISE sensors like Nitrate, Ammonium, and Chloride for details.

## Sensor Maintenance



Each sensor has unique maintenance requirements. See the individual sensor sections for details about maintaining and calibrating each sensor.

## Wiper Maintenance



Replace brush according to site needs when bristles are visibly bent, damaged, or fouled.

### REPLACE WIPER BRUSH



Loosen brush housing with hex key.



Slide the old brush off of the wiper shaft.



Align flat sides of brush holder and shaft. Install new brush.



Tighten brush screw with hex key.

# Aqua TROLL Sensors

Aqua TROLL multiparameter instruments use interchangeable sensors to measure water quality parameters. The sensors are shared between Aqua TROLL 500, 600, 700, and 800 instruments. Each sensor has different calibration and maintenance requirements and different parameter settings available.



It's critical to follow the correct procedures to get accurate data from your instrument, so take some time to familiarize yourself with the information in the following sections for each sensor you plan to use.

## Sensor Options

Available sensors include:

- Temperature
- Conductivity/Temperature
- pH/ORP
- Rugged Dissolved Oxygen (RDO®)
- Turbidity
- Ammonium (ISE)
- Nitrate (ISE)
- Chloride (ISE)
- Chlorophyll a
- Phyco cyanin (BGA-PC)
- Phycoerythrin (BGA-PE)
- FDOM
- Crude Oil
- Rhodamine Water Tracer
- Fluorescein Water Tracer

## Installing Sensors



Remove any storage or dust covers from sensor. Save these for later storage.



Apply a pea-sized drop of lubricant to sensor O-rings.



Insert sensor in empty sensor port.



Tighten screw at base of sensor with hex wrench. Do not overtighten.

## Removing Sensors



Remove the restrictor.



Use the hex wrench to loosen the set screw on the base of the sensor.



Use the small notch at the bottom of the sensor to remove the sensor.



Slide sensor out of port.

## Sensor Summary

SENSORS	EXPECTED LIFETIME*	RECOMMENDED USER CALIBRATION FREQUENCY	PRESSURE RATING - PSI	USABLE DEPTH M   FT		OPERATIONAL TEMPERATURE RANGE
pH/ORP	2 years or greater**	10 to 12 weeks**	350	250	820	- 5 to 50° C
RDO	Years	12 months**	350	250	820	- 5 to 50° C
Conductivity	Years	Only if needed	350	250	820	- 5 to 50° C
Temperature	Years	N/A	350	250	820	- 5 to 50° C
Turbidity	Years	Only if needed	350	250	820	- 5 to 50° C
Pressure	Years	Only if needed	12.8	9	30	- 5 to 50° C
			14.2	10	33	
			42.7	30	100	
			108	76	250	
			142	100	328	
			285	200	650	
			350	250	820	
Barometric Pressure	Years	Only if needed	NA	NA	NA	- 5 to 50° C
Ammonium	6 to 12 months**	Dependent on site and storage conditions	30	25	70	0 to 40° C
Chloride	1 year or greater**	Dependent on site and storage conditions	350	250	820	0 to 50° C
Nitrate	6 to 12 months**	Dependent on site and storage conditions	30	25	70	0 to 40° C
Chlorophyll a	Years	Only if needed	350	250	820	- 5 to 50° C
BGA-PC	Years	Only if needed	350	250	820	- 5 to 50° C
BGA-PE	Years	Only if needed	350	250	820	- 5 to 50° C
Rhodamine	Years	Only if needed	350	250	820	- 5 to 50° C
Fluorescein	Years	Only if needed	350	250	820	- 5 to 50° C
FDOM	Years	Only if needed	350	250	820	- 5 to 50° C
Crude Oil	Years	Only if needed	350	250	820	- 5 to 50° C

\* Expected lifetime includes total shelf life and deployment lifetime.

\*\* Lifetime and calibration frequency depend on site and storage conditions.

## Solutions Summary

SOLUTION	SHELF LIFE - UNOPENED	SHELF LIFE - OPENED
Quick Cal	4 months. Store in a cool, dark place. Shake before use.	7 to 21 days ( $\pm 10$ mV, $\pm 0.05$ pH, $\pm 50$ $\mu$ S/cm)
ZoBell's	9 months. Store in a cool, dark place.	3 to 6 months
Low Conductivity (147 $\mu$ S/cm)	12 months	Hours ( $\pm 1$ $\mu$ S/cm, check before use)
Other Conductivity	12 months	3 to 6 months
pH Calibration Buffers	24 months	3 to 6 months
Reference Filling Solution	24 months	12 months
pH Storage Solution	24 months	12 months
Sodium Sulfite	12 months	3 to 6 months
Turbidity	12 months	12 months from expiration date
Deionized Water	24 months	Hours, check before use
Ammonium	12 months	3 to 6 months
Chloride	12 months	3 to 6 months
Nitrate	12 months	3 to 6 months

## Fluorometer Wavelengths

SENSOR	EXCITATION WAVELENGTH (NOMINAL)	DETECTION WAVELENGTH
Chlorophyll a	430 nm	675 nm to 750 nm
BGA-PC	590 nm	640 nm to 690 nm
BGA-PE	498 nm	575 nm to 625 nm
Rhodamine	530 nm	580 nm to 660 nm
Fluorescein	462 nm	525 nm to 570 nm
FDOM	375 nm	455 nm to 530 nm
Crude Oil	365 nm	430 nm to 505 nm

# Conductivity and Temperature Sensors

## About the Sensor

The temperature and conductivity sensors provide a fast-response and accurate measurement of temperature on the Aqua TROLL multiparameter platforms. The combination conductivity and temperature sensor also measures conductivity, specific conductivity, salinity, total dissolved solids (TDS), resistivity, and density.

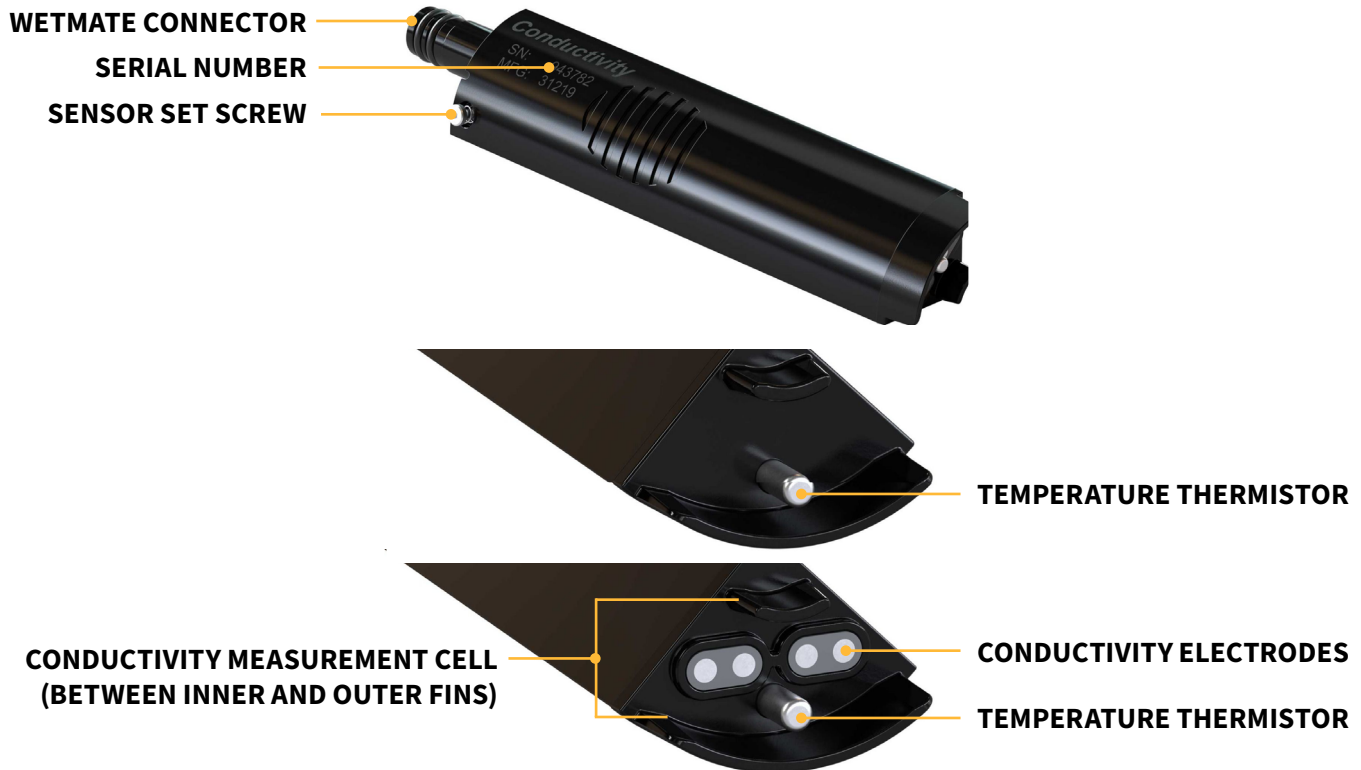

## How It Works

The temperature thermistor (short for thermally sensitive resistor) is a raised titanium pin that changes electrical resistance with the temperature. The change in resistance is used by the instrument to calculate temperature. Because the conductivity of a solution changes heavily with temperature, the conductivity sensor also includes a temperature sensor. Many parameter calculations depend highly on temperature, and the temperature reading is also used to compensate measurements from other sensors.

Conductivity is a measure of a solution's ability to conduct electricity. Since electricity needs charged particles in order to flow, a higher concentration of ions in a solution typically correlates with higher conductivity.

The Aqua TROLL conductivity sensor contains four electrodes in a conductivity cell. Two fins define the conductivity cell measurement area and help decrease external interference. The cell contains two outer drive electrodes and two inner sensing electrodes driven by an alternating current. Conductance is calculated according to a modified version of Ohms Law:  $G=I/V$ , where  $G$  is conductance in siemens,  $V$  is voltage, and  $I$  is current. Conductance is then converted to conductivity in  $\mu\text{S}/\text{cm}$  or  $\text{mS}/\text{cm}$  using a cell constant which adjusts for the physical geometry of the measurement cell.

In-Situ's sensors are factory calibrated across their full range. Because of this, they tend to maintain very accurate readings without need for frequent user calibration. In-Situ's sensors use a cell constant (K-Cell Value) that is normalized to 1 based on the factory calibrated value. A sensor at factory defaults will have a cell constant of 1 which can be adjusted by calibration. 2-point calibrations also include an offset from the factory zero-point value.

## Best Practices for Fast Temperature Response Time



To ensure the fastest and most accurate readings, fully submerge the entire instrument, especially the restrictor. When possible, maintain flow around the sensor rather than allowing it to sit in stagnant water.

Because temperature is used to compensate so many other measurements, the response time of the temperature sensor has a high impact on the response time of other sensors.

The temperature sensor is engineered and tested for fast, accurate readings, but like all sensors, it depends on the surrounding solution being truly representative of the overall water body. Any parts of the instrument left above the water can conduct or retain heat and affect the temperature of the water near the sensor. To ensure the fastest and most accurate readings, fully submerge the entire instrument, especially the restrictor, when moving between samples of different temperatures. When possible, maintain water flow around the sensor rather than allowing it to sit in stagnant water.

## Preferred Temperature



For highest accuracy and fastest response time, it's best to use a dedicated temperature or conductivity/temperature sensor.

The instrument will use the fastest, most accurate temperature available from the set of sensors installed in the instrument at the time. The following sensors return high-accuracy temperature with a fast response time and are preferred for temperature readings:

1. Temperature Sensor
2. Conductivity/Temperature Sensor

If one of these sensors is not available or returns an error, the instrument will revert to using a temperature reading from another sensor or the internal instrument temperature to continue to deliver readings. These sensors have slower response time and may not reflect the water temperature as accurately:

3. Fluorometer internal thermistors
4. Instrument internal temperature

## Specific Conductivity

Conductivity represents the reading measured directly by the sensor which will fluctuate as the temperature changes. Specific conductivity is normalized to a single reference temperature, so the specific conductivity will remain consistent even as the temperature of the solution changes. Because of this, specific conductivity is used for calibrations. Specific conductivity has the same units as conductivity.

By default, the conductivity sensor uses a reference temperature of 25° C. You can change the reference temperature to 20° C during conductivity calibration. The reference temperature used for calibration will be applied to all subsequent readings of conductivity taken by the sensor. You can view the current reference temperature by generating a Calibration Report in VuSitu.

## Resistivity

Resistivity is simply the reciprocal of conductivity, converted to ohm\*cm. Resistivity is often used to report measurement results instead of conductivity in high purity water applications.

## Salinity

Salinity is a measure of salts dissolved in the water reported in the unitless value of PSU (Practical Salinity Units). By default, the instrument uses a method derived from Standard Method 2520 B to calculate salinity from conductivity and temperature.

You can also set the instrument to use Practical Salinity Scale 78 (PSS78) to derive salinity from conductivity, Temperature, and Pressure. For highest accuracy, confirm that your instrument has a pressure sensor if you wish to use this method. You can change the salinity calculation method under **Instrument Settings** in VuSitu.

## Density

Density of water in g/cm<sup>3</sup> is calculated from salinity and temperature in accordance with Standard Methods 2520 C. See also:

Millero, F. J. and Huang, F.: The density of seawater as a function of salinity (5 to 70 g kg<sup>-1</sup>) and temperature (273.15 to 363.15 K), *Ocean Sci.*, 5, 91–100, <https://doi.org/10.5194/os-5-91-2009>, 2009.

## Total Dissolved Solids (TDS)



To find the scale factor, start by determining total dissolved solids. Then divide TDS by the specific conductivity reading: **Scale factor = TDS (in mg/L) ÷ Specific conductivity (in μS/cm)**

Total Dissolved Solids are any dissolved materials in water. These materials affect the water's conductivity. The instrument can derive an estimate for TDS based on a linear correlation with specific conductivity. The linear scale factor is unique to each deployment site and can change over time based on the nature of the specific solids. The default scale factor is 0.65. You can adjust this scale factor to be more accurate for your deployment site based on laboratory analysis of grab samples. EPA Method 160.1 provides step-by-step guidance for finding the total dissolved solids of a grab sample. Once you have determined TDS and calculated the scale factor, you can input the scale factor in VuSitu under **Instrument Settings > Derived Parameters**.

$$\begin{array}{ccc} 500 \mu\text{S/cm} & * & 0.65 = 325 \text{ mg/L} \\ \text{SPECIFIC} & \text{SCALE} & \text{DERIVED} \\ \text{CONDUCTIVITY} & \text{FACTOR} & \text{TDS} \end{array}$$

See also:

Hem, J. D. 1985. Study and interpretation of the chemical characteristics of natural water. 3rd ed. USGS Water Supply Paper 2254, 67. <https://doi.org/10.3133/wsp225>

## Additional Information

For additional sensor details including accuracy, range, resolution, methodology, detection limits, response time, and more, see the Aqua TROLL sensor specification sheet at [www.in-situ.com](http://www.in-situ.com).

For more information about these parameters and their applications, visit [www.in-situ.com](http://www.in-situ.com).



Conductivity and temperature sensors do not require special preparation. Apply a thin layer of grease to the connector O-rings before installing any sensor in the instrument.

## Chemical Incompatibility



Do not soak the conductivity sensor in vinegar for long periods of time. Follow the cleaning instructions below to clean the sensor.

## Cleaning



Rinse the sensor face with clean, cold water. If further cleaning is needed, clean the sensor based on the nature of the debris. Begin with the gentlest method and continue to the others only if necessary.

### TO REMOVE CRYSTALLINE DEPOSITS:



**1** Clean the sensor with warm water and mild soap.



**2** Use a soft brush to gently clean all debris from the electrodes and thermistor.



**3** Soak the sensor in 5% HCl solution for 10-30 minutes followed by warm soapy water and soft brushing.



**4** If deposits persist, alternate soaking in 5% HCl and 5% NaOH followed by soapy water and soft brushing.

### TO REMOVE OILY OR GREASY RESIDUE:



Do not soak the sensor in strong solvents, such as chlorinated solvents, ethers, or ketones, such as acetone.



**1** Clean the sensor with warm water and mild soap.



**2** Use a soft brush to gently clean all debris from the electrodes and thermistor.



**3** Soak the sensor in methanol or isopropyl alcohol for up to 1 hour.



**4** Thoroughly rinse the sensor with deionized water.

### TO REMOVE PROTEIN-LIKE MATERIAL, OR SLIMY FILM:



**1** Clean the sensor with warm water and mild soap.



**2** Use a soft brush to gently clean all debris from the electrodes and thermistor.

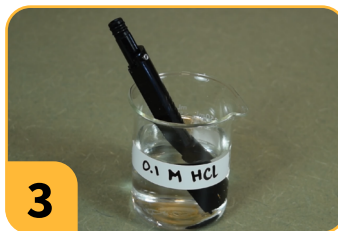

**3** Soak the sensor in 0.1 M HCl solution for 10 minutes.



**4** Thoroughly rinse the sensor with deionized water.

## Recommended Calibration Frequency

In-Situ's sensors are rigorously calibrated in our factory across their full range with the same NIST-traceable standards we offer for field calibrations. Because of this, they tend to maintain very accurate readings without need for frequent user calibration.

You can calibrate the sensor to compensate for physical change to the measurement cell (deposits on the sensor face or electrodes that cannot be removed, physical damage to the sensor face or electrodes, etc.) or if you have Standard Operating Procedures that require calibration. Prior to calibration, clean the sensor and insert it into a known Specific Conductivity standard to determine if the sensor is reading within the accuracy range required for your application. If the readings are within the required accuracy range, calibration is not necessary.

You can check the current cell constant and reference temperature by generating a Calibration Report in VuSitu. Choose **Restore Calibration Defaults** from **Instrument Settings** to return to the last factory calibration.

User calibration of temperature is not required to maintain accurate readings and is not available.

## 1-Point vs 2-Point Calibrations

If you determine that conductivity calibration is necessary, or if you have Standard Operating Procedures that require calibration, a 1-point calibration is sufficient for most applications. See below for guidance on when a 2-point calibration might be needed.



Use a 1-point calibration when the deployment environment has a narrow range of conductivity values and you are using In-Situ calibration standard.

Most applications with relatively stable conductivity only require a single-point calibration. In-Situ's sensors are factory calibrated across their full range, so there's no need to calibrate the sensor at more than one calibration point. You can choose **Restore Calibration Defaults** in VuSitu to return to the last factory calibration.



Use a 2-point calibration when the deployment environment has a wide range of conductivity values.

In environments like estuaries where the conductivity can vary significantly, perform a 2-point calibration spanning the full range of conductivity you expect to measure.



Use a 2-point calibration when you are trying to create a correlation to a third-party calibration standard.

Because there may be variations in calibration standards from different manufacturers, perform a 2-point calibration if you are using calibration standards from a different manufacturer.

## Choosing Calibration Standards



For 1-point calibrations, use the calibration standard closest to your expected deployment conditions.



For 2-point calibrations, use one calibration standard below the lowest end of the range you expect to measure, and one calibration standard above the highest end of the range you expect to measure. Always work from the lowest concentration standard to the highest.

# Calibration Procedure



You can batch calibrate a group of conductivity sensors at the same time to reduce time and calibration solution.

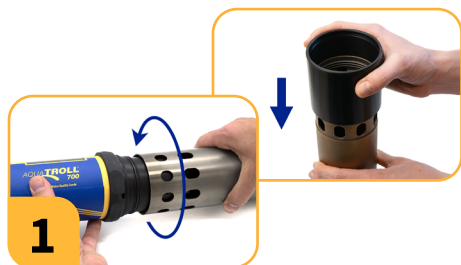

**1** Place the restrictor in calibration mode (holes near the center of the instrument). If you are using a copper restrictor, install the calibration sleeve.

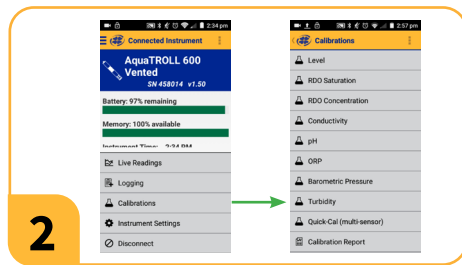

**2** In VuSitu, click Calibrations from the Connected Instrument screen and choose sensor to calibrate.



**3** Remove cap from instrument and pour DI water into restrictor. Use 10-20 mL for Aqua TROLL 500 or 600. Use 20-40 mL for Aqua TROLL 700 or 800.



**4** Gently shake the sonde in a circular motion to rinse the inside of restrictor and sensors. Discard the DI water and repeat rinsing procedure two more times with your first calibration standard.



**5** Pour calibration solution into the restrictor up to the bottom of the threads and cover with the end cap.



**6** Follow the instructions in VuSitu to complete the calibration.



You can also perform a single-point field calibration on pH, ORP, and conductivity sensors at the same time using Quick Cal solution. Choose Quick Cal in VuSitu, then choose the parameters to calibrate.

## Shelf Life for In-Situ Solutions

SOLUTION	SHELF LIFE - UNOPENED	SHELF LIFE - OPENED
Low Conductivity (147 $\mu\text{S}/\text{cm}$ )	12 months	Hours ( $\pm 1 \mu\text{S}/\text{cm}$ , check before use)
Other Conductivity (available in 1413, 12890, 58670 $\mu\text{S}/\text{cm}$ )	12 months	3 to 6 months
Quick Cal Solution	4 months. Store in a cool, dark place. Shake before use.	7 to 21 days ( $\pm 10 \text{ mV}$ , $\pm 0.05 \text{ pH}$ , $\pm 50 \mu\text{S}/\text{cm}$ )
Deionized Water	24 months	Hours, check before use for calibration

## Checking Calibration Quality



After calibration, check these indicators in the VuSitu Calibration Report. If you are logged in, Calibration Reports will automatically upload to HydroVu for secure storage and access from any device.

INDICATOR	ACCEPTABLE RANGE	NOTES
Cell Constant	0.7 to 1.3	The cell constant is normalized to 1 based on the factory calibrated value. A sensor at factory defaults will have a cell constant of 1.

If the values are outside of the ranges listed above, follow these troubleshooting steps. Then try the calibration again.

- Thoroughly clean, rinse, and dry the sensor, restrictor, and calibration equipment.
- Make sure you are using enough calibration solution as described in the calibration procedure in this manual.
- Check that calibration solutions are not expired.
- From **Instrument Settings**, select **Restore Calibration Defaults**. Then try calibrating again.
- Check whether the sensor is reaching the end of its expected life. It may be time to replace your sensor.

## Maintenance



Conductivity and temperature sensors do not have unique maintenance requirements aside from cleaning as described in this manual. Change the connector O-rings as part of routine instrument maintenance.

## Storage



Conductivity and temperature sensors do not have any unique storage requirements. It can be stored wet or dry. Cover the connector with the included dust cover when it is not in use to protect the connector from corrosion or fouling.

## Expected Sensor Life

Follow all recommendations in this manual to maximize the life of your sensor. Conductivity and temperature sensors can last years depending on site and storage conditions. The lifetime may be reduced if the instrument is installed in abrasive or corrosive conditions, cleaned improperly, or deployed outside of its operational temperature and pressure ranges.

# pH/ORP Sensor

## About the Sensor

The In-Situ pH and ORP sensor is a combination three-electrode sensor featuring a single junction and refillable reference solution. The sensor allows for accurate water quality data, minimal maintenance, and simplified data collection.



## How pH Measurement Works

The pH sensor measures the potential difference across a pH-sensitive glass bulb. The bulb is a glass electrode that has nanoscopic pores to allow only the tiniest of ions ( $H^+$ ) to interact. The Aqua TROLL pH sensor uses a round bulb to improve response time through increased surface area. The sensing system is filled with a standard solution that maintains a constant pH. As ions interact with the glass bulb, a potential difference develops due to the concentration difference of hydrogen ions on either side of the bulb. A separate reference system maintains a consistent electric potential regardless of changes in pH outside the sensor. In-Situ pH sensors include both the pH and reference electrodes as half-cells in one unit.

The reference system consists of a silver wire coated in silver chloride in a mixed potassium chloride/silver chloride (KCl/AgCl) solution. The reference junction is porous to allow electrolytes to slowly diffuse out and maintain electrical contact with the sample. The necessity of the porous junction and slow leakage of the reference solution gives the sensor a relatively short lifespan. Errors or drift in pH readings are usually due to issues with the reference solution or junction. Regularly refilling the reference solution and replacing the junction will significantly extend the sensor's life. Eventually the glass electrode becomes ineffective, and the sensor will need to be replaced.

pH is calculated with the Nernst equation:

$$E_{cell} = E^0 - \left[ 2.3 \frac{RT}{nF} \right] \log(Q)$$

Where:

- $E_{cell}$  = potential of the sensing electrode
- $E^0$  = potential of the reference electrode
- R = Gas Law constant
- T = temperature (in Kelvin)
- n = ionic charge (for  $H^+$ , n = 1)
- F = Faraday's constant
- Q = Reaction quotient

The slope term shown in brackets simplifies to -59.2 mV/decade at 25°C. It can be adjusted by user calibration to adjust for aging and other physical factors of the electrodes, and also depends on temperature.

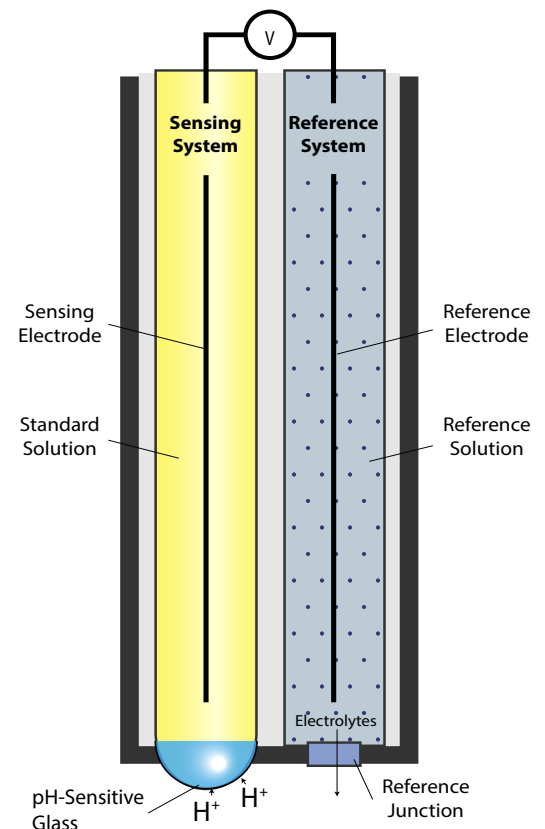

## How ORP Measurement Works

The ORP sensor uses a platinum electrode to measure the Oxidation-Reduction Potential (ORP) of a solution. Unlike the pH sensor or ISE sensors, the sensing electrode is not ion-selective and does not require a semi-permeable membrane. As oxidizing or reducing agents interact with the sensing electrode, they create a polarization across the electrode which is measured as a potential in conjunction with the reference electrode. The ORP sensor uses the same reference electrode as the pH sensor.

The measurement electrode is not affected by temperature, and ORP measurements reflect the actual sensor mV value that is not compensated for temperature. However, temperature affects the rate at which the oxidizing and reducing reactions in a sample of water will occur, thus affecting the overall ORP of the sample. Calibration standards for ORP will have different mV values at different temperatures.

## Potential Interferents

### pH INTERFERENTS

The pH glass bulb selects for very small ion size. It may be subject to interference from sodium cations ( $\text{Na}^+$ ) at  $\text{pH} > 12$ .

### ORP INTERFERENTS

The ORP electrode may be subject to interference from ions that are stronger reducing agents than hydrogen or platinum, e.g., chromium, vanadium, titanium, etc.

## Expected Sensor Life

Follow all storage, cleaning and maintenance recommendations to maximize the life of your sensor. A well-maintained sensor can last 2 years or longer (total shelf and deployment lifetime from the date of manufacture) depending on site and storage conditions. The lifetime may be reduced if the instrument is installed in abrasive or corrosive conditions, stored or cleaned improperly, or deployed outside of its operational temperature and pressure ranges.

## Additional Information

For more information about these parameters and their applications, view the pH parameter page at [www.in-situ.com](http://www.in-situ.com).

For additional sensor details including accuracy, range, resolution, methodology, detection limits, response time, and more, see the Aqua TROLL Sensor Specification sheet at [www.in-situ.com](http://www.in-situ.com).

## Chemical Incompatibility



Do not store ISE sensors or pH sensors in distilled or DI water. It will deplete the reference solution and drastically reduce the life of the sensor.



Do not soak the sensor in strong solvents, such as chlorinated solvents, ethers, or ketones, such as acetone.

## Installation Requirements



pH measurements depend on temperature. To read pH, you must have a Temperature sensor or a Conductivity/Temperature Sensor installed.

## Preparing the pH/ORP Sensor



Follow these steps before deploying your sensor for the first time or after long-term storage to ensure accurate data.



Replace the sensor fill solution (see instructions on the following pages).



Apply grease to the O-rings and install the sensor in the instrument.



Calibrate the sensor with the VuSitu mobile app.

# Cleaning



Salt crystals may form on the sensor during shipping or storage. These are normal and will not interfere with sensor performance. Rinse with deionized water to remove any buildup.



Potential salt buildup. Rinse with deionized water if necessary.



If further cleaning is needed, clean the sensor based on the nature of the debris. Begin with the gentlest cleaning method and continue to the others only if necessary. Do not directly wipe the glass bulb.

## TO REMOVE CRYSTALLINE DEPOSITS:



1 Clean the sensor with warm water and mild soap.



2 Soak the sensor in 5% HCl solution for 10 to 30 minutes.



3 If deposits persist, alternate soaking in 5% HCl and 5% NaOH solutions.



4 Thoroughly rinse the sensor with deionized water.

## TO REMOVE OILY OR GREASY RESIDUE:



Do not soak the sensor in strong solvents, such as chlorinated solvents, ethers, or ketones, such as acetone.



1 Clean the sensor with warm water and mild soap.

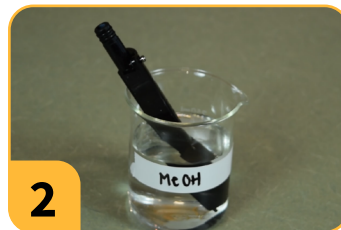

2 Soak the sensor in methanol or isopropyl alcohol for up to 1 hour.



3 Thoroughly rinse the sensor with deionized water.

## TO REMOVE PROTEIN-LIKE MATERIAL, OR SLIMY FILM:



1 Clean the sensor with warm water and mild soap.

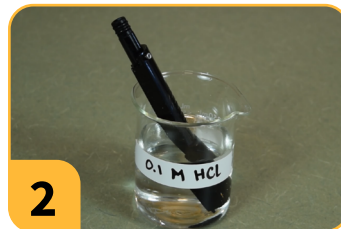

2 Soak the sensor in 0.1 M HCl solution for 10 minutes.



3 Thoroughly rinse the sensor with deionized water.

# Recommended Calibration Frequency

Requirements for calibration can range from every day to every 10-12 weeks or even longer depending on your program needs and deployment conditions. Deployment environments with low ion concentration, wide temperature fluctuations, high temperatures, or fouling will require more frequent cleaning and calibration.

Prior to calibration, clean the sensor and insert it into a known calibration standard to determine if the sensor is reading within the accuracy range required for your application. If the readings are outside of the accuracy range, you may need to calibrate more frequently for your site conditions.

## Calibration Procedure



Do not attempt to calibrate a pH or ISE sensor with DI water. Ions in the calibration solution are required for accurate calibration.



For best results, perform at least a two-point calibration. Use the calibration standards closest to your expected deployment conditions.

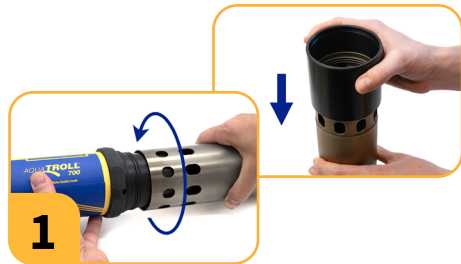

Place the restrictor in calibration mode (holes near the center of the instrument). If you are using a copper restrictor, install the calibration sleeve.

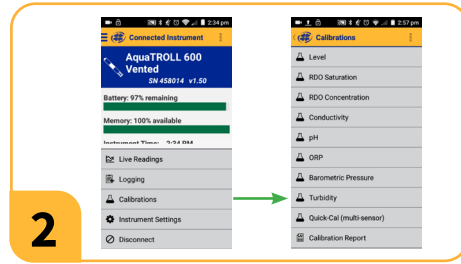

In VuSitu, click Calibrations from the Connected Instrument screen and choose sensor to calibrate.



Remove cap from instrument and pour DI water into restrictor. Use 10-20 mL for Aqua TROLL 500 or 600. Use 20-40 mL for Aqua TROLL 700 or 800.



Gently shake the sonde in a circular motion to rinse the inside of restrictor and sensors. Discard the DI water and repeat rinsing procedure two more times with your first calibration standard.



Pour calibration solution into the restrictor to a depth of 1 cm above the sensor faces. Cover the restrictor with the end cap.



Follow the instructions in VuSitu to start the calibration.



You can batch calibrate a group of pH sensors at the same time to reduce time and calibration solution. Always make sure you have a temperature sensor installed during calibration.



You can also perform a single-point field calibration on pH, ORP, and conductivity sensors at the same time using Quick Cal solution. Choose Quick Cal in VuSitu, then choose the parameters to calibrate.

## Checking Calibration Quality



After calibration, check these indicators in the VuSitu Calibration Report. If you are logged in, Calibration Reports will automatically upload to HydroVu for secure storage and access from any device.

INDICATOR	ACCEPTABLE RANGE	NOTES
pH 2- or 3- Point Slope pH 2- or 3- Point Offset	-66 to -50 mV/decade $\pm 30$ mV at pH 7	Theoretically ideal slope: -59.2 mV/decade Theoretically ideal offset: 0 mV/decade
pH 4 Standard	$177 \pm 30$ mV	Use standards closest to expected deployment conditions
pH 7 Standard	$0 \pm 30$ mV	Use standards closest to expected deployment conditions
pH 10 Standard	$-177 \pm 30$ mV	Use standards closest to expected deployment conditions
ORP Offset	$\pm 30$ mV	Applies to both Zobell's and Quick Cal standards

If the values are outside of the ranges listed above, follow these troubleshooting steps. Then try the calibration again.

- Thoroughly clean, rinse, and dry the sensor, restrictor, and calibration equipment.
- Make sure you are using enough calibration solution as described in the calibration procedure in this manual.
- Check that calibration solutions are not expired.
- Follow instructions to replace the sensor fill solution. If the calibration still fails, replace the reference junction.
- Check that the fill solution chamber is completely filled with no air bubbles.
- From Instrument Settings, select Restore Calibration Defaults. Then try calibrating again.
- Make sure the sensor has been stored properly according to the instructions in this manual.
- Check whether the sensor is reaching the end of its expected life. It may be time to replace your sensor.

## Shelf Life for In-Situ Solutions

SOLUTION	SHELF LIFE - UNOPENED	SHELF LIFE - OPENED
pH Calibration Standard (Available in pH 4, 7, and 10)	12 months	3 to 6 months
Zobell's ORP Standard	9 months. Store in a cool, dark place.	3 to 6 months
Quick Cal Solution	4 months. Store in a cool, dark place. Shake before use.	7 to 21 days ( $\pm 10$ mV, $\pm 0.05$ pH, $\pm 50$ $\mu$ S/cm)
Deionized Water	24 months	Hours, check before use for calibration
Sensor Reference Filling Solution	24 months	12 months
pH Storage Solution	24 months	12 months

## Replacing the Sensor Fill Solution and Reference Junction

The sensor fill solution has a shelf life of 2 years. Replace the fill solution every 5 to 6 months or when:

1. The sensor fails to calibrate within the acceptable slope or standard mV ranges.
2. Sensor readings vary or are slow to respond.
3. Readings in a known standard are outside the accuracy range for the sensor.

If the sensor still fails to calibrate after replacing the fill solution, replace the reference junction.



Follow the procedure below to replace the sensor fill solution and/or the reference junction.



**1** Remove sensor from sonde and unscrew reference junction.



**2** Don't dump solution down the drain. Pour it onto a paper towel and discard.



**3** Lightly shake the bottle of reference filling solution to mix.



**4** Insert the fill tube into the bottom of reservoir.



**5** Squeeze a steady stream of solution into the reservoir while slowly pulling out the tube.



**6** Overfill slightly. Reinstall the reference junction and tighten until it touches sensor body. Turn 90° more to secure.



**7** Rinse the sensor thoroughly. Reinstall the sensor in the instrument and calibrate with VuSitu.

## Storage



Do not store the pH/ORP sensor or ISE sensors in DI water. It will deplete the reference solution and drastically reduce the life of the sensor.



**1** Dampen the storage cap sponge with Storage Solution or pH 4 calibration standard.



**2** Place the cap with the sponge on the sensor.



**3** Use electrical tape to seal the storage cap.



**4** Place a dust cover over the sensor connector.



pH/ORP sensors require maintenance after long-term storage to properly measure data. Follow the instructions under Preparing the pH Sensor before deploying the sensor.

# Rugged Dissolved Oxygen (RDO®) Sensor

## About the Sensor

The RDO sensor uses RDO Technology, which is an EPA-approved method for optical dissolved oxygen measurement. It provides an accurate and stable dissolved oxygen (DO) measurement. This RDO foil is designed to withstand harsh environmental conditions while providing best-in-class accuracy.



## How It Works

The sensor operates with a process called dynamic luminescence quenching. This technology is described in Standard Method 4500-O and In-Situ Methods 1002-8-2009, 1003-8-2009, 1004-8-2009 (EPA Approved).

The sensor uses a special RDO cap with a gas-permeable sensing foil. The sensing foil contains lumiphore molecules which fluoresce when excited by blue light. A blue LED inside the sensor emits blue light, and the sensing foil in turn emits red photons. If oxygen is present, the oxygen molecules quench this fluorescence, so fewer red photons are emitted. This method measures the phase shift (or delay) of the returned signal, and is thus based on the fluorescence lifetime rather than intensity. The phase difference between the blue light and the returned red light is used to calculate the concentration of oxygen in the water. Determination of DO concentration by luminescence quenching has a linear response over a range of concentrations.

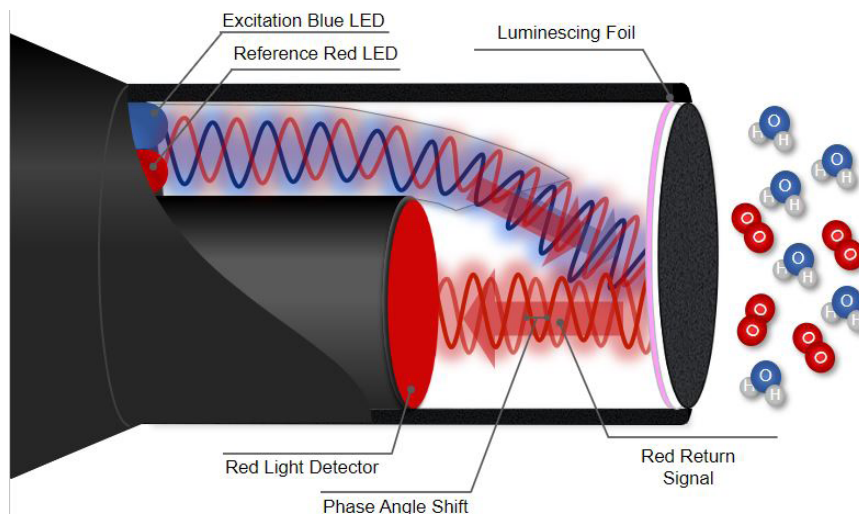

RDO Technology uses a unique three-layer system to protect the luminescing layer, which extends the life of the sensor cap. This construction allows the cap to withstand rapid flow rates, high sediment loads and a wide range of demanding environments, lasting up to years of continuous use and cleaning. The cap is replaceable to extend the life of the overall sensor.

For additional sensor details see the Aqua TROLL sensor specification sheet at [www.in-situ.com](http://www.in-situ.com). For more information about this parameter and its applications, view the parameter page at [www.in-situ.com](http://www.in-situ.com).

## Dissolved Oxygen Concentration

Dissolved oxygen is most commonly measured in milligrams per liter (mg/L), percent saturation or parts per million (PPM). Milligrams per liter and parts per million indicate concentration—a quantitative measure of the amount of DO per given volume of water. The direct output from the factory-calibrated RDO cap is partial pressure of oxygen in torr. Oxygen concentration  $C_O$  (mg/L) is calculated as follows:

$$C_O = 31.9988 \times 10^6 \times \frac{\rho_w P_O}{k_0 M_w} (1 - \theta_O P) \times S_c$$

Where:

**$\rho_w$  is the density of water in g/cm<sup>3</sup>**

$$\ln(\rho_w) = -0.589581 + (326.785/T) - (45,284.1/T^2)$$

T is the temperature in Kelvin

**$P_O$  is the partial pressure of O<sub>2</sub> in atmospheres:**

$$P_O = P_{\text{torr}} / 759.999876$$

$P_{\text{torr}}$  is the ppO<sub>2</sub> measured value

**$k_0$  is Henry's law constant:**

$$\ln(k_0) = 3.71814 + (5596.17/T) - (1,049,668/T^2)$$

T is the temperature in Kelvin

**$M_w$  is the molar mass of water:**

$$M_w = 18.0152 \text{ g/mole}$$

**$\theta_O$  is the negative of the second pressure coefficient in the virial expansion for the real gas behavior of oxygen:**

$$\theta_O = 0.000975 - (1.426 \times 10^{-5}t) + (6.436 \times 10^{-8}t^2)$$

t is temperature in °C

$\theta_O$  is tied to the compressibility of pure oxygen at a given temperature and corrects for non-ideal gas behavior.

**P is the total pressure in atm**

**$S_c$  is the salinity correction:**

$$\ln(S_c) = S(B_0 + B_1 T_s + B_2 T_s^2 + B_3 T_s^3) + C_0 S^2$$

$$B_0 = -6.246090 \times 10^{-3}$$

$$B_1 = -7.423444 \times 10^{-3}$$

$$B_2 = -1.048635 \times 10^{-2}$$

$$B_3 = -7.987907 \times 10^{-3}$$

$$C_0 = -4.679983 \times 10^{-7}$$

$T_s$  is the scaled temperature:

$$T_s = \ln [(298.15 - t) / (273.15 + t)]$$

t is temperature in °C

S is the salinity in psu

Salinity correction is either taken from a conductivity sensor or input by a user.

## Dissolved Oxygen Saturation

Percent saturation is a relative measure of how much oxygen is present compared to the theoretical amount of oxygen a body of water can hold at equilibrium. Oxygen saturation  $O_2\%Sat$  is calculated as follows:

$$O_2\%Sat = \frac{O_2Reading}{O_2100\%Sat}$$

Where:

**$O_2$ Reading is the mg/L reading from the RDO sensor**

**$O_2100\%Sat$  is the theoretical saturation value in mg/L:**

$$O_2100\%Sat = 31.9988 \times 10^6 \times \frac{\rho_w [0.20946 \times (P - P_{wv})]}{k_0 M_w} (1 - \theta_O P) \times S_c$$

Where:

**$P_{wv}$  is the partial pressure of water vapor at saturation in atm:**

$$\ln(P_{wv}) = 11.8571 - (3840.70/T) - (216,961/T^2)$$

All other variables are the same as defined for Dissolved Oxygen Concentration.

## References

Per Standard Methods 4500-O(c). See also:

Benson and Krause, Jr. The concentration and isotopic fractionation of gases dissolved in freshwater in equilibrium with the atmosphere. *Limnol, Oceanogr*, 25(4), 1980, 662-671

Gordon and Garcia Oxygen Solubility in Seawater: Better Fitting Equations *Limnol, Oceanogr*, 37(6), 1992, 1307-1312

## Potential Interferents

Oxidizers (e.g., sodium permanganate or potassium permanganate) will give falsely high readings

## Compensation for Other Parameters

### TEMPERATURE

Dissolved oxygen readings depend highly on temperature. For most accurate readings, use the RDO Sensor with a temperature sensor. If no temperature sensor is present, the instrument will use a less accurate temperature reading from a different sensor (e.g. fluorometers) or the internal sonde temperature to calculate dissolved oxygen values. See the Temperature section of this manual to learn more.

### SALINITY

If a conductivity sensor is present, dissolved oxygen readings include automatic salinity compensation by default. If you don't have a conductivity sensor or prefer to enter a custom value, you can input an estimated value for salinity in the VuSitu mobile app under **Instrument Settings > RDO Salinity Setting**.

### BAROMETRIC PRESSURE

The barometric pressure is updated with every reading when using a vented instrument or a VuLink with barometric compensation enabled. For best accuracy, use VuLink or a vented system, and make sure all vents are clear before taking readings or calibrating.

If you are using a non-vented instrument without a VuLink, the barometric pressure is updated during calibration or instrument battery changes. Calibrate the instrument every time there are significant changes in altitude or barometric pressure to ensure the barometric pressure is updated for the deployment site.

# RDO Cap Chemical Incompatibility



The following chemicals will damage the RDO sensing element.

- Alcohols > 5%
- Hydrogen peroxide > 3%
- Sodium hypochlorite (commercial bleach) > 3%
- Gaseous sulfur dioxide
- Gaseous chlorine
- Organic solvents (e.g., acetone, chloroform, methylene chloride, etc.)
- Ozone

## Installation Requirements



Dissolved oxygen readings depend on temperature. For most accurate readings, use the RDO Sensor with a temperature sensor.



This sensor does not require special preparation. RDO sensors don't require hydration and read accurately within 90 seconds of going from dry to wet conditions. Apply a thin layer of grease to the connector O-rings before installing any sensor in the instrument.

## Cleaning the Sensor



Do not use organic solvents—they will damage the sensor cap. Do not remove the sensor cap during general cleaning.



1

Keep the cap on the sensor during cleaning. Rinse the sensor with clean water.



2

Gently wipe with a soft-bristled brush or soft cloth to remove bio-fouling.



3

To remove mineral build-up, soak the sensor in vinegar for 15 minutes, then in DI water for 15 minutes.

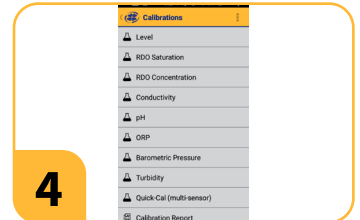

4

After cleaning the sensor, perform a 100% Saturation calibration.

## Recommended Calibration Frequency

Every RDO cap is factory-calibrated at 90 discrete points. The unique calibration coefficients for each cap are stored in a memory chip embedded in the cap. The sensor automatically loads the factory data when a new cap is installed.



Perform a 100% saturation calibration whenever you change the cap, clean the sensor, or move the instrument to a new location with changes in altitude or barometric pressure.

RDO sensor user calibrations apply a slope and offset to the factory calibration. It's not necessary to calibrate both RDO concentration and saturation because they adjust the same slope and offset. For most applications, the factory calibration is the most accurate for the zero point. Perform a zero-point calibration only if you plan to measure very low dissolved oxygen levels (<2 mg/L).

## RDO 100% Saturation Calibration: Water Saturated Air

Use the procedure below to calibrate the Aqua TROLL RDO sensor, or see the next section for an alternative method.



**1** Remove the restrictor and dry RDO sensing foil and temperature sensor.



**2** Place the restrictor in calibration mode (holes near the center of the instrument). If you are using a copper restrictor, install the calibration sleeve.



**3** Saturate a small sponge with water. Place the sponge on the restrictor cap.



**4** Loosely install the end cap, keeping the sensor face dry and allowing for air flow.



**5** Leave sponge in restrictor for five minutes.

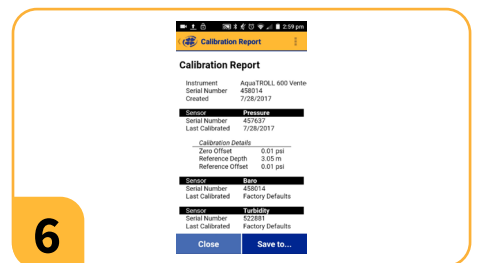

**6** Follow the instructions in VuSitu to finish calibration.

## RDO 100% Saturation Calibration: Saturation Bubbler

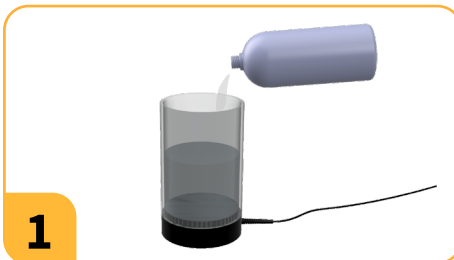

**1** Fill a 100% saturation bubbler two-thirds with tap water.



**2** Turn on bubbler and allow 5-10 minutes for 100% saturation.



**3** Make sure the sonde is in deployment mode with the holes near the end of the instrument. If you are using a copper restrictor, do not install the calibration sleeve.



**4** Place sonde into bubbler.

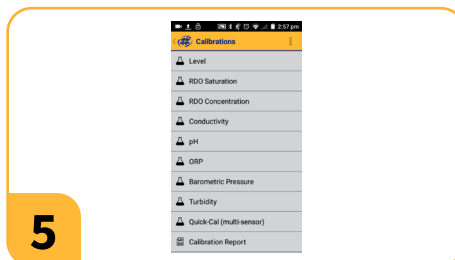

**5** Open the VuSitu mobile app and tap Calibrations > RDO Saturation.

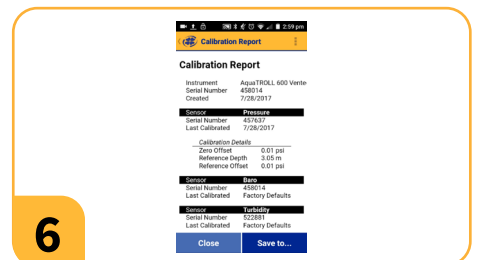

**6** Follow instructions in VuSitu to finish calibration.

## RDO 0% Saturation: Sodium Sulfite



For most applications, the factory calibration is the most accurate for the zero point. Perform a two-point calibration only if you plan to measure very low dissolved oxygen levels (<2 mg/L).

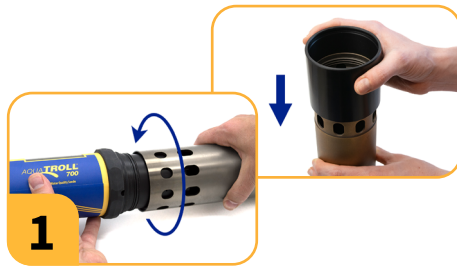

1 Place the restrictor in calibration mode (holes near the center of the instrument). If you are using a copper restrictor, install the calibration sleeve.

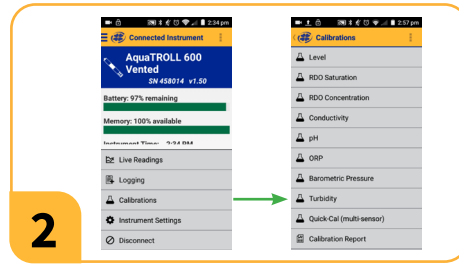

2 In VuSitu, click Calibrations from the Connected Instrument screen and choose RDO Saturation. Choose 0% and 100% calibration points.



3 Remove cap from instrument and pour DI water into restrictor. Use 10-20 mL for Aqua TROLL 500 or 600. Use 20-40 mL for Aqua TROLL 700 or 800.



4 Gently shake the sonde in a circular motion to rinse the inside of restrictor and sensors. Discard the DI water and repeat rinsing procedure two more times with calibration standard.



5 Pour calibration solution into the restrictor to a depth of 1 cm above the sensor faces. Cover the restrictor with the end cap.



6 Follow the instructions in VuSitu to start the calibration.

## RDO Concentration



You can calibrate RDO concentration to match a reading from a known reference sensor. It's not necessary to calibrate both RDO concentration and saturation because they adjust the same slope and offset.

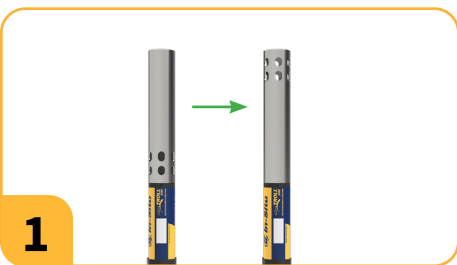

1 Make sure the sonde is in deployment mode with the holes near the end of the instrument. If you are using a copper restrictor, do not install the calibration sleeve.

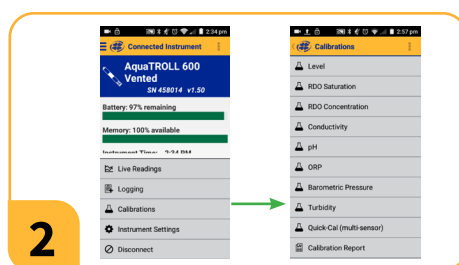

2 In VuSitu, click Calibrations from the Connected Instrument screen and choose sensor to calibrate.



3 Place instrument in reference solution or next to reference device. Enter the reference value in VuSitu.

## Checking Calibration Quality



After calibration, check these indicators in the VuSitu Calibration Report. If you are logged in, Calibration Reports will automatically upload to HydroVu for secure storage and access from any device.

INDICATOR	ACCEPTABLE RANGE	NOTES
Slope	0.7 to 1.3	The slope is normalized based on the factory calibrated value. A sensor at factory defaults will have a slope of 1.
Offset	±0.3 mg/L	A sensor at factory defaults will have an offset of 0.

If the values are outside of the ranges listed above, follow these troubleshooting steps. Then try the calibration again.

- Thoroughly clean, rinse, and dry the sensor, restrictor, and calibration equipment.
- Check that the RDO sensing foil, temperature thermistor, and conductivity sensor are free from bubbles and condensation.
- For sodium sulfite calibrations, make sure you are using enough calibration solution as described in the calibration procedure in this manual. Check that calibration solutions are not expired.
- Check that the instrument has a temperature or conductivity-temperature sensor installed.
- Make sure all barometric pressure vents are unblocked.
- If you are using a bubbler or a reference sensor, make sure the instrument is in deployment mode with the holes toward the end of the instrument.
- From **Instrument Settings**, select **Restore Calibration Defaults**. Then try calibrating again.
- Follow the instructions in this manual to replace the RDO cap.
- Check whether the sensor is reaching the end of its expected life. It may be time to replace your sensor.

## Shelf Life for In-Situ Solutions

SOLUTION	SHELF LIFE - UNOPENED	SHELF LIFE - OPENED
Quick Cal	4 months. Store in a cool, dark place. Shake before use.	7 to 21 days (±10 mV, ±0.05 pH, ±50 µS/cm)
Sodium Sulfite	12 months	3 to 6 months
Deionized Water	24 months	Hours, check before use for calibration

## Replacing the RDO Cap

Over time, the sensing foil may wear down and the cap will need to be replaced. Cap lifetimes vary depending on the type of cap (Fast vs RDO-X), the deployment conditions, and wiper interval.



In typical conditions, replace the Fast cap every year and the RDO-X cap every 2 years. Replace the RDO Cap if the sensing foil is visibly degraded, when calibration fails, or when sensor readings are no longer within the sensor accuracy specification even after calibration.



Do not wet the lens with any liquid. Avoid touching or cleaning the lens with anything other than the supplied lens cloth. Do not transfer grease to the lens or metal contacts.



Remove the sensor from the instrument. Use a lint-free cloth to dry the sensor.

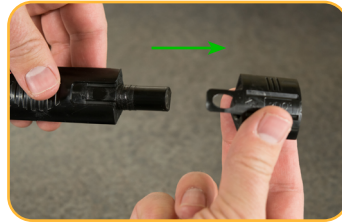

Without twisting, push up under the tab and pull the used cap from the sensor.

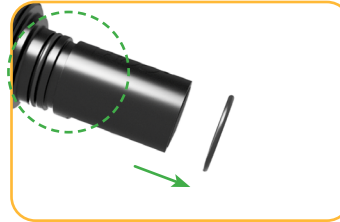

Remove the existing O-rings from the sensor. Check that the O-ring grooves are dry.



Use your finger to apply a light layer of grease around the O-ring grooves.



Place the new O-rings on the sensor. Apply another thin layer of grease to the O-rings and grooves.



Clean the lens on the sensor with the supplied cloth. Allow the lens to dry thoroughly and inspect for scratches or dirt.

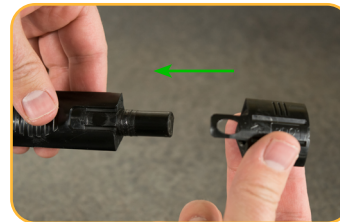

Push the cap onto the sensor until it snaps into place. Check that the O-rings are not pinched between the cap and sensor.

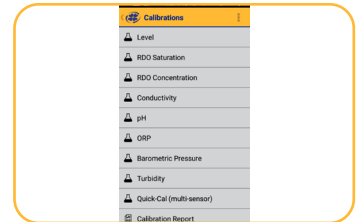

After replacing the cap, perform a 100% Saturation Calibration.

## Storage



The RDO Sensor can be stored wet or dry. Cover the connector with the included dust cover when it is not in use to protect the connector from corrosion or fouling.



Never store the RDO sensor without the sensor cap once it has been installed on the sonde.

## Expected Sensor Life

Follow all recommendations in this manual to maximize the life of your sensor. RDO sensors can last 2 years or longer depending on site and storage conditions. The lifetime may be reduced if the instrument is installed in abrasive or corrosive conditions, cleaned improperly, or deployed outside of its operational temperature and pressure ranges.

# Turbidity Sensor

## About the Sensor

The Aqua TROLL Turbidity Sensor measures the scattering of light by particles in solution. This sensor addresses the drawbacks of traditional field turbidity sensors with ambient light rejection, integrated optical compensation and low-cost, non-hazardous calibration.



## How It Works

Turbidity is the scattering of light by suspended particles in a solution. Turbid waters are murky, cloudy, and difficult to see through. Suspended matter, microscopic organisms, and bubbles all raise the turbidity of water. Turbidity can indicate the health of a natural body of water, serve as an indicator of runoff into surface water systems, and provide a reasonable correlation with laboratory-analyzed total suspended solids (TSS) for a specific deployment site.

Many turbidity sensors measure light intensity to quantify turbidity. An LED light source transmits a beam of light through a solution. As the light passes through the solution, suspended particles scatter the light. A photodetector inside the sensor receives light scattered by the particles and calculates a turbidity value in Nephelometric Turbidity Units (NTU) or Formazin Nephelometric Units (FNU).

In-Situ's Aqua TROLL turbidity sensors are nephelometers that use the ISO 7027 method to measure turbidity. This method relies on an infrared LED to emit light, with the photodetector positioned at a 90 degree angle. A sensor that does not achieve this angle cannot be viewed as ISO 7027 compliant. ISO 7027 defines NTU and FNU as numerically equivalent, and the instrument can report values in either unit.

The sensor uses a secondary reference detector to automatically correct the primary measurement for changes in the LED light source. Integrated optical compensation provides stability at much lower limits of turbidity and significantly reduces drift over temperature and time.

Aqua TROLL turbidity sensors are designed to minimize interference from ambient light and run with a unique LED frequency signature from In-Situ's other optical sensors. This allows the photodetector within the turbidity sensor to isolate its light source and provide the same degree of accuracy regardless of lighting conditions, deployment location, and other installed optical sensors.

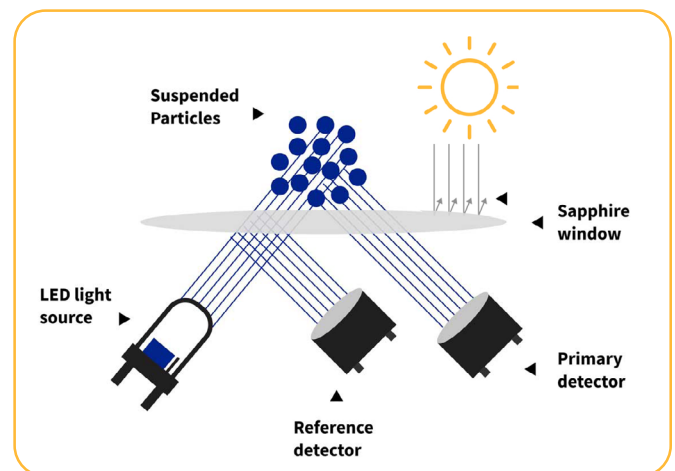

To accurately quantify turbidity, the light scattered by the sample must be compared to a the light scattered by a known reference solution. It is important to use In-Situ turbidity standards for calibration which have been formulated to match formazin standards for the specific geometry and wavelengths of In-Situ sensors.

## Total Suspended Solids (TSS)



To find the scale factor, start by determining total suspended solids. Then divide TSS by the turbidity reading: **Scale factor = TSS (in mg/L) ÷ Turbidity (in NTU)**

Turbidity and total suspended solids (TSS) measurements are related, but the two are measured using different processes and cannot be used interchangeably. Suspended solids are measured by mass and recorded in milligrams per liter (mg/L). Turbidity, by contrast, is not a measure of the mass or quantity of particles in a sample, but of their ability to scatter light. It is an optical measurement of how cloudy or hazy the water is based on how these particles alter the passage of light through the water. While TSS includes many of the materials that contribute to turbidity in the water column, such as sediment, clay, algae and other organic and inorganic materials, these suspended particles can differ in size and composition, giving two solutions with the same TSS value very different turbidities.

But, while the measurements represent different qualities of a water sample, turbidity and TSS are still related. Higher TSS does mean there are more particles to scatter light, so turbidity values are often higher when TSS measurements are high. Turbidity, therefore, can provide a reasonable estimate of total suspended solids in a water body, but it must be correlated on a site-specific basis. And though a good tool for estimating TSS, turbidity values do not represent the amount of TSS at the site.

The instrument can derive an estimate for TSS based on a linear correlation with turbidity. The linear scale factor is unique to each deployment site and can change over time based on the nature of the specific solids. You can enable this parameter and enter a linear scale factor for your deployment site based on laboratory analysis of grab samples. EPA Method 160.2 provides step-by-step guidance for finding the total suspended solids of a grab sample. Once you have determined TSS and calculated the scale factor, you can input the scale factor in VuSitu under **Instrument Settings > Derived Parameters**. An example calculation is shown below for reference.

$$\begin{array}{ccc} 54.8 \text{ NTU} & * & 1.248 = 68.4 \text{ mg/L} \\ \text{TURBIDITY} & \text{SCALE} & \text{DERIVED} \\ & \text{FACTOR} & \text{TSS} \end{array}$$

## About Turbidity Calibration Standards

Unlike parameters where the concentration of a substance is absolute and can be determined by grab sample analysis, turbidity is an optical property of the solution as a whole. The size and shape of suspended particles significantly impacts their optical properties in solution. Likewise, the specific geometry and wavelengths of different sensors can have a different response in the same solution. For a sensor to accurately quantify turbidity, the light scattered by the sample must be standardized against the light scattered by a known reference solution.

Formazin is the traditional calibration standard for turbidity sensors. FNU stands for Formazin Nephelometric Units. Formazin is a polymer that forms into a stable colloidal solution with uniform particle size, which makes it excellent for reproducible calibrations across different sensors. In-Situ turbidity sensors can be calibrated with formazin made following ISO 17034:2016. However, formazin is toxic and raises environmental concerns around disposal. For this reason, safer polymer bead standards are more commonly used for turbidity calibrations.

It is very important to use In-Situ turbidity standards for calibration which have been formulated to match ISO 17034:2016 formazin for the specific geometry and wavelengths of In-Situ sensors. Polymer bead standards from other manufacturers will not produce accurate calibration results.

## Additional Information

For more information about these parameters and their applications, view the Turbidity parameter page at [www.in-situ.com](http://www.in-situ.com).

For additional sensor details including accuracy, range, resolution, methodology, detection limits, response time, and more, see the Aqua TROLL sensor specification sheet at [www.in-situ.com](http://www.in-situ.com).



The turbidity sensor does not require special preparation. Apply a thin layer of grease to the connector O-rings before installing any sensor in the instrument.

## Chemical Incompatibility



Do not use solvents or metal scraping tools to clean the sensor. Follow the cleaning procedure described below to clean the sensor.

## Cleaning



Rinse the sensor face with clean, cold water. If further cleaning is needed, clean the sensor based on the nature of the debris. Begin with the gentlest method and continue to the others only if necessary.

### TO REMOVE SOFT FOULING:



**1** Clean the sensor with warm water and mild soap.

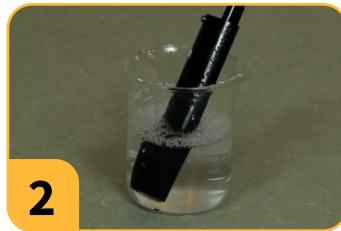

**2** Soak the sensor in dish soap and warm water.



**3** Use a soft brush to gently clean all debris from the lenses.



**4** Thoroughly rinse the sensor with deionized water.

### TO REMOVE HARD FOULING:



Do not soak the sensor in strong solvents, such as chlorinated solvents, ethers, or ketones, such as acetone.



**1** Clean the sensor with warm water and mild soap.



**2** Soak the sensor in dilute vinegar.



**3** Use a soft brush to gently clean all debris from the lenses.



**4** Thoroughly rinse the sensor with deionized water.

## Choosing Calibration Standards



For 1-point calibrations, use the calibration standard closest to your expected deployment conditions.



For 2-point calibrations, use one calibration standard below the lowest end of the range you expect to measure, and one calibration standard above the highest end of the range you expect to measure.

# Recommended Calibration Frequency

In-Situ's sensors are rigorously calibrated in our factory across their full range with the same NIST-traceable standards we offer for field calibrations. Because of this, they tend to maintain very accurate readings without need for frequent user calibration.

You can calibrate the sensor to compensate for physical change to the lenses or if you have Standard Operating Procedures that require calibration. Prior to calibration, clean the sensor and insert it into a known Turbidity standard to determine if the sensor is reading within the accuracy range required for your application. If the readings are within the required accuracy range, calibration is not necessary. Choose **Restore Calibration Defaults** from **Instrument Settings** to return to the last factory calibration. You can also perform a calibration check or a zero-point calibration using DI water.

# Calibration Procedure



You must calibrate the turbidity sensor with In-Situ's turbidity standard or formazin. Polymer bead standards from other manufacturers will not produce accurate calibration results.



You can batch calibrate a group of turbidity sensors at the same time to reduce time and calibration solution.

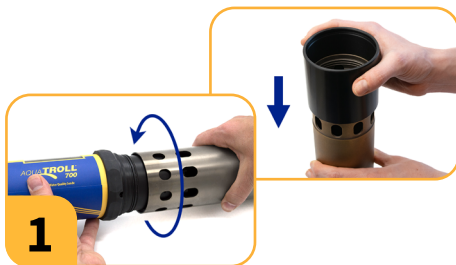

1 Place the restrictor in calibration mode (holes near the center of the instrument). If you are using a copper restrictor, install the calibration sleeve.

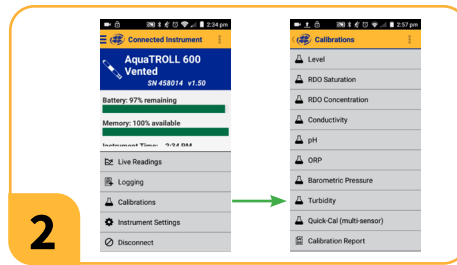

2 In VuSitu, click Calibrations from the Connected Instrument screen and choose sensor to calibrate.



3 Remove cap from instrument and pour DI water into restrictor. Use 10-20 mL for Aqua TROLL 500 or 600. Use 20-40 mL for Aqua TROLL 700 or 800.



4 Gently shake the sonde in a circular motion to rinse the inside of restrictor and sensors, then discard the DI water. Because turbidity is an optical measurement, rinsing with calibration solution is not necessary.



5 Pour calibration solution into the restrictor to a depth of 1 cm above the sensor faces. Cover the restrictor with the end cap.

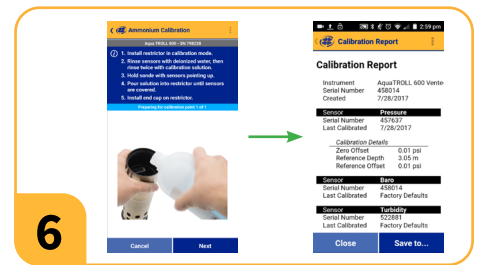

6 Follow the instructions in VuSitu to start the calibration.

## Checking Calibration Quality



After calibration, check these indicators in the VuSitu Calibration Report. If you are logged in, Calibration Reports will automatically upload to HydroVu for secure storage and access from any device.

INDICATOR	ACCEPTABLE RANGE	NOTES
Slope	0.7 to 1.3	A sensor at factory defaults will have a slope of 1.

If the values are outside of the ranges listed above, follow these troubleshooting steps. Then try the calibration again.

- Thoroughly clean, rinse, and dry the sensor, restrictor, and calibration equipment.
- Make sure you are using enough calibration solution as described in the calibration procedure in this manual. Always cover the restrictor with the end cap during calibration.
- Make sure you are using In-Situ calibration solution or formazin. Polymer bead standards from other manufacturers will not produce accurate calibration. Check that calibration solutions are not expired.
- From Instrument Settings, select Restore Calibration Defaults. Then try calibrating again.
- Inspect the lenses for scratches, smudges, or condensation inside the sensor. If you notice major scratches or internal condensation and the sensor is not calibrating properly, you may need to replace your sensor.
- Make sure the sensor has been stored properly according to the instructions in this manual.
- Check whether the sensor is reaching the end of its expected life. It may be time to replace your sensor.

## Shelf Life for In-Situ Solutions

SOLUTION	SHELF LIFE - UNOPENED	SHELF LIFE - OPENED
Turbidity (available in 10, 100, 1000, 2000, or 4000 NTU)	12 months	12 months from expiration date
Deionized Water	24 months	Hours, check before use for calibration

## Maintenance



Turbidity sensors do not have unique maintenance requirements aside from cleaning as described in this manual. Change the connector O-rings as part of routine instrument maintenance.

## Storage



The turbidity sensor does not have any unique storage requirements. It can be stored wet or dry. Cover the connector with the included dust cover when it is not in use to protect the connector from corrosion or fouling.

## Expected Sensor Life

Follow all recommendations in this manual to maximize the life of your sensor. Turbidity sensors can last years depending on site and storage conditions. The lifetime may be reduced if the instrument is installed in abrasive or corrosive conditions, cleaned improperly, or deployed outside of its operational temperature and pressure ranges.

# Ammonium Sensor

## About the Sensor

The In-Situ Ammonium Ion-Selective Electrode (ISE) Sensor measures ammonium levels in natural water, surface water, groundwater, produced water and aquaculture applications. The Ammonium Sensor will automatically derive ammonia and total ammonia when used in conjunction with a pH/ORP and conductivity/temperature sensor.



## How It Works

In-Situ ammonium sensors are ion-selective electrodes (ISEs). Ammonium ions interact with a membrane that is selective based on ion charge and size. The sensing system is filled with a standard solution that maintains a constant concentration of ammonium ions. As ions interact with the membrane, a potential difference develops due to the concentration difference of ammonium ions on either side of the membrane. A separate reference system maintains a consistent electric potential regardless of changes in ammonium outside the sensor. In-Situ ammonium sensors include both the ammonium electrode and reference electrode as half-cells in one unit.

The reference system consists of a silver wire coated in silver chloride in a mixed potassium chloride/silver chloride (KCl/AgCl) solution. The reference junction is porous to allow electrolytes to slowly diffuse out and maintain electrical contact with the sample. Like all ISEs, the necessity of the porous junction and slow leakage of the reference solution gives the sensor a relatively short lifespan. Errors or drift in ammonium readings are usually due to issues with the reference solution or junction. Regularly refilling the reference solution and replacing the junction will significantly extend the sensor's life. Eventually the membrane becomes ineffective, and the sensor will need to be replaced.

Ammonium concentration is calculated with the Nernst equation:

$$E_{cell} = E^0 - \left[ 2.3 \frac{RT}{nF} \right] \log(Q)$$

Where:

- $E_{cell}$  = potential of the sensing electrode
- $E^0$  = potential of the reference electrode
- R = Gas Law constant
- T = temperature (in Kelvin)
- n = ionic charge (for  $\text{NH}_4^+$ , n = 1)
- F = Faraday's constant
- Q = Reaction quotient

The slope term shown in brackets simplifies to 59.2 mV/decade at 25°C. It can be adjusted by user calibration to adjust for aging and other physical factors of the electrodes, and also depends on temperature.

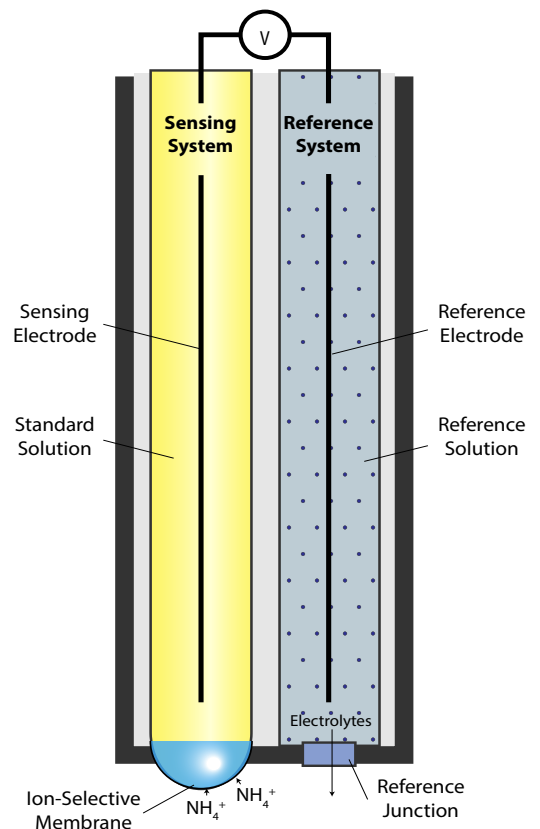

## Potential Interferents

Ammonium ISE sensors select for ammonium ions based on size and charge. They are subject to interference from other univalent cations and are not well suited to brackish or ocean environments. The table below lists concentrations of possible interfering ions that cause 10% error at various levels (in ppm) of  $\text{NH}_4^+$ .

ION	AT 100 PPM $\text{NH}_4^+$	AT 10 PPM $\text{NH}_4^+$	AT 1 PPM $\text{NH}_4^+$
Cesium ( $\text{Cs}^+$ ) ppm	100	10	1
Potassium ( $\text{K}^+$ ) ppm	270	27	2.7
Thallium ( $\text{Tl}^+$ ) ppm	3100	310	31
pH ( $\text{H}^+$ ) ppm	pH 1.6	pH 2.6	pH 3.6
Silver ( $\text{Ag}^+$ ) ppm	270,000	27,000	2,700
Lithium ( $\text{Li}^+$ ) ppm	35,000	3,500	350
Sodium ( $\text{Na}^+$ ) ppm	11,100	1,100	110

## Free and Total Ammonia Calculation

Ammonia ( $\text{NH}_3$ ) and ammonium ( $\text{NH}_4^+$ ) exist in equilibrium. Ammonium ( $\text{NH}_4^+$ ) forms when an extra hydrogen atom attaches to ammonia. When ammonia dissolves in water or another solution, some amount of it will bond with hydrogen to become ammonium. The pH of the solution will influence how much ammonia is converted to ammonium. A low pH will result in more ammonium, while a high pH will result in more ammonia:



The Ammonium ISE sensor directly measures ammonium concentration ( $\text{NH}_4^+$  only). The sensor will automatically calculate free ammonia ( $\text{NH}_3$  only) and total ammonia (both  $\text{NH}_3$  and  $\text{NH}_4^+$ ) when used with a pH/ORP sensor and a conductivity/temperature sensor:

$$[\text{NH}_3] = [\text{NH}_4^+] \times 10^{pH - pK_a(T,S)}$$

Where:

$[\text{NH}_3]$  is the dissolved ammonia concentration in mg/L.

$[\text{NH}_4^+]$  is the ammonium concentration in mg/L.

T is temperature in Celsius.

S is salinity, in ppt (parts per thousand).

pH is the acidity.

$pK_a(T,S)$  is the ammonia dissociation constant:

$$pK_a(T,S) = 10.0423 - 0.0315536T + 0.003071S$$

## Additional Information

For more information about these parameters and their applications, view the Ammonia/Ammonium parameter page at [www.in-situ.com](http://www.in-situ.com).

For additional sensor details including accuracy, range, resolution, methodology, detection limits, response time, and more, see the Aqua TROLL Sensor Specification sheet at [www.in-situ.com](http://www.in-situ.com).

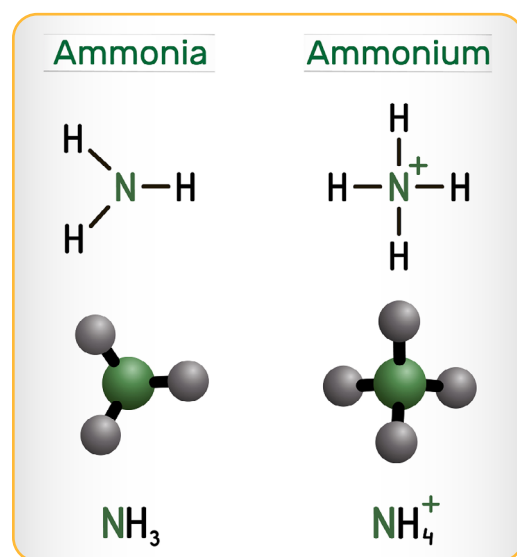

References: T. G. Bell, M. T. Johnson, T. D. Jickells, P. S. Liss. Ammonia/ammonium dissociation coefficient in seawater: a significant numerical correction. Environ. Chem. 2007, 4, 183–186.

T. G. Bell, M. T. Johnson, T. D. Jickells, P. S. Liss. Ammonia/ammonium dissociation coefficient in seawater: a significant numerical correction. Environ. Chem. 2008, 5, 258.

## Chemical Incompatibility



Do not store ISE sensors or pH sensors in DI water. It will deplete the reference solution and drastically reduce the life of the sensor.



Do not soak the sensor in strong solvents, such as chlorinated solvents, ethers, or ketones, such as acetone.

## Installation Requirements



ISE sensors require one or more additional sensors. You must install the required sensors described below.

### TO MEASURE AMMONIUM...

Ammonium measurements depend on temperature. To read ammonium, you must have ONE of the following sensors installed:

- Temperature Sensor OR Conductivity/Temperature Sensor

### TO CALCULATE AMMONIA OR TOTAL AMMONIA...

Ammonia calculations depend on temperature, conductivity, and pH. To read ammonia, you must have BOTH of the following sensors installed:

- Conductivity/Temperature Sensor AND
- pH/ORP Sensor

## Preparing Ion-Selective Electrode Sensors



Follow these steps before deploying your sensor for the first time or after long-term storage to ensure accurate data.



**1** Replace the sensor fill solution (see instructions on the following pages).



**2** Soak sensor for 2-24 hours in 140 mg/L calibration standard or the highest standard you plan to use, whichever is greater.



**3** Apply grease to the O-rings and install the sensor in the instrument.



**4** Calibrate the sensor with the VuSitu mobile app.

# Cleaning



Salt crystals may form on the sensor during shipping or storage. These are normal and will not interfere with sensor performance. Rinse with deionized water to remove any buildup.



Potential salt buildup. Rinse with deionized water if necessary.



If further cleaning is needed, clean the sensor based on the nature of the debris. Begin with the gentlest cleaning method and continue to the others only if necessary. Do not directly wipe the membrane.

## TO REMOVE CRYSTALLINE DEPOSITS:



1 Clean the sensor with warm water and mild soap.



2 Soak the sensor in 5% HCl solution for 10 to 30 minutes.



3 If deposits persist, alternate soaking in 5% HCl and 5% NaOH solutions.



4 Thoroughly rinse the sensor with deionized water.

## TO REMOVE OILY OR GREASY RESIDUE:



Do not soak the sensor in strong solvents, such as chlorinated solvents, ethers, or ketones, such as acetone.



1 Clean the sensor with warm water and mild soap.

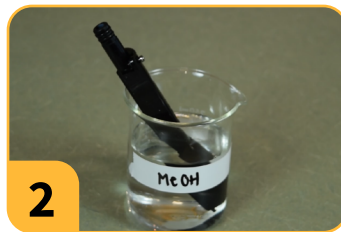

2 Soak the sensor in methanol or isopropyl alcohol for up to 1 hour.



3 Thoroughly rinse the sensor with deionized water.

## TO REMOVE PROTEIN-LIKE MATERIAL, OR SLIMY FILM:



1 Clean the sensor with warm water and mild soap.

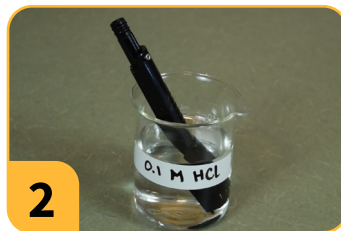

2 Soak the sensor in 0.1 M HCl solution for 10 minutes.



3 Thoroughly rinse the sensor with deionized water.

# Recommended Calibration Frequency

Requirements for calibration can range from daily to monthly or even longer depending on your program needs and deployment conditions. Deployment environments with low ion concentration, wide temperature fluctuations, high temperatures, or fouling will require more frequent cleaning and calibration.

Prior to calibration, clean the sensor and insert it into a known calibration standard to determine if the sensor is reading within the accuracy range required for your application. If the readings are outside of the accuracy range, you may need to calibrate more frequently for your site conditions.

## Calibration Procedure



For best results, perform at least a two-point calibration. Use the calibration standards closest to your expected deployment conditions.



Do not attempt to calibrate a pH or ISE sensor with DI water. Ions in the calibration solution are required for accurate calibration.



You can batch calibrate a group of ammonium sensors at the same time to reduce time and calibration solution. Always make sure you have a temperature sensor installed during calibration.

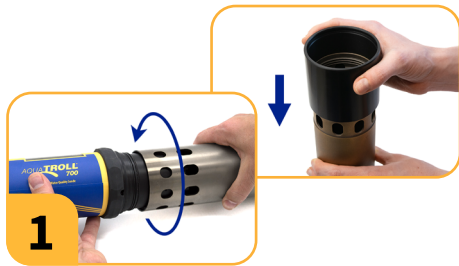

1 Place the restrictor in calibration mode (holes near the center of the instrument). If you are using a copper restrictor, install the calibration sleeve.

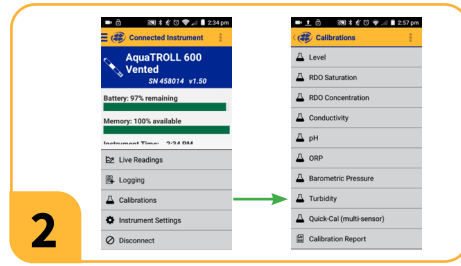

2 In VuSitu, click Calibrations from the Connected Instrument screen and choose sensor to calibrate.



3 Remove cap from instrument and pour DI water into restrictor. Use 10-20 mL for Aqua TROLL 500 or 600. Use 20-40 mL for Aqua TROLL 700 or 800.



4 Gently shake the sonde in a circular motion to rinse the inside of restrictor and sensors. Discard the DI water and repeat rinsing procedure two more times with your first calibration standard.



5 Pour calibration solution into the restrictor to a depth of 1 cm above the sensor faces. Cover the restrictor with the end cap.

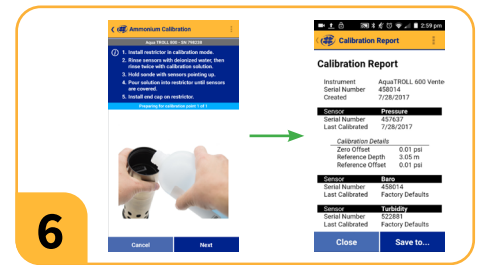

6 Follow the instructions in VuSitu to start the calibration.

## Checking Calibration Quality



After calibration, check these indicators in the VuSitu Calibration Report. If you are logged in, Calibration Reports will automatically upload to HydroVu for secure storage and access from any device.

INDICATOR	ACCEPTABLE RANGE	NOTES
Slope	> 20 mV/decade	Theoretically ideal slope: 59.2 mV/decade
14 mg/L Standard	64.35 ±30 mV	Use the standard closest to expected deployment conditions
140 mg/L Standard	120.2 ±30 mV	Use the standard closest to expected deployment conditions
1400 mg/L Standard	176.2 ±30 mV	Use the standard closest to expected deployment conditions

If the values are outside of the ranges listed above, follow these troubleshooting steps. Then try the calibration again.

- Thoroughly clean, rinse, and dry the sensor, restrictor, and calibration equipment.
- Make sure you are using enough calibration solution as described in the calibration procedure in this manual.
- Check that calibration solutions are not expired.
- Follow the instructions to replace the sensor fill solution. If the calibration still fails, replace the reference junction.
- Check that the fill solution chamber is completely filled with no air bubbles.
- From Instrument Settings, select Restore Calibration Defaults. Then try calibrating again.
- Make sure the sensor has been stored properly according to the instructions in this manual.
- Check whether the sensor is reaching the end of its expected life. It may be time to replace your sensor.

## Shelf Life for In-Situ Solutions

SOLUTION	SHELF LIFE - UNOPENED	SHELF LIFE - OPENED
Ammonium Standard as N (available in 14, 140, 1400 mg/L)	12 months	3 to 6 months
Deionized Water	24 months	Hours, check before use for calibration
Sensor Reference Filling Solution	24 months	12 months
Storage Solution	24 months	12 months

## Expected Sensor Life

Follow all storage, cleaning and maintenance recommendations to maximize the life of your sensor. A well-maintained sensor can last 6-12 months (total shelf and deployment lifetime from the date of manufacture) depending on site and storage conditions. The lifetime may be reduced if the instrument is installed in abrasive or corrosive conditions, stored or cleaned improperly, or deployed outside of its operational temperature and pressure ranges.

# Replacing the Sensor Fill Solution and Reference Junction

The sensor fill solution has a shelf life of 2 years. Replace the fill solution every 5 to 6 months or when:

1. The sensor fails to calibrate within the acceptable slope or standard mV ranges.
2. Sensor readings vary or are slow to respond.
3. Readings in a known standard are outside the accuracy range for the sensor.

If the sensor still fails to calibrate after replacing the fill solution, replace the reference junction.



Follow the procedure below to replace the sensor fill solution and/or the reference junction.



**1** Remove sensor from sonde and unscrew reference junction.



**2** Don't dump solution down the drain. Pour it onto a paper towel and discard.



**3** Lightly shake the bottle of reference filling solution to mix.



**4** Insert the fill tube into the bottom of reservoir.



**5** Squeeze a steady stream of solution into the reservoir while slowly pulling out the tube.



**6** Overfill slightly. Reinstall the reference junction and tighten until it touches sensor body. Turn 90° more to secure.



**7** Soak sensor for 2-24 hours in 140 mg/L calibration standard or the highest standard you plan to use, whichever is greater.



**8** Rinse the sensor thoroughly. Reinstall the sensor in the instrument and calibrate with VuSitu.

## Storage



Do not store the pH/ORP sensor or ISE sensors in DI water. It will deplete the reference solution and drastically reduce the life of the sensor.



**1** Dampen the storage cap sponge with Storage Solution or pH 4 calibration standard.



**2** Place the cap with the sponge on the sensor.



**3** Use electrical tape to seal the storage cap.



**4** Place a dust cover over the sensor connector.



ISE sensors require maintenance after long-term storage to properly measure data. Follow the instructions under Preparing Ion-Selective Electrode Sensors before deploying the sensor.

# Nitrate Sensor

## About the Sensor



The In-Situ Nitrate Ion-Selective Electrode (ISE) Sensor measures nitrate levels in natural water, surface water, groundwater, produced water and aquaculture applications.



## How It Works

In-Situ nitrate sensors are ion-selective electrodes (ISEs). Nitrate ions interact with a membrane that is selective based on ion charge and size. The sensing system is filled with a standard solution that maintains a constant concentration of nitrate ions. As ions interact with the membrane, a potential difference develops due to the concentration difference of nitrate ions on either side of the membrane. A separate reference system maintains a consistent electric potential regardless of changes in nitrate outside the sensor. In-Situ nitrate sensors include both the nitrate electrode and reference electrode as half-cells in one unit.

The reference system consists of a silver wire coated in silver chloride in a mixed potassium chloride/silver chloride (KCl/AgCl) solution. The reference junction is porous to allow electrolytes to slowly diffuse out and maintain electrical contact with the sample. Like all ISEs, the necessity of the porous junction and slow leakage of the reference solution gives the sensor a relatively short lifespan. Errors or drift in nitrate readings are usually due to issues with the reference solution or junction. Regularly refilling the reference solution and replacing the junction will significantly extend the sensor's life. Eventually the membrane becomes ineffective, and the sensor will need to be replaced.

Nitrate concentration is calculated with the Nernst equation:

$$E_{cell} = E^0 - \left[ 2.3 \frac{RT}{nF} \right] \log(Q)$$

Where:

- $E_{cell}$  = potential of the sensing electrode
- $E^0$  = potential of the reference electrode
- R = Gas Law constant
- T = temperature (in Kelvin)
- n = ionic charge (for  $\text{NO}_3^-$ , n = -1)
- F = Faraday's constant
- Q = Reaction quotient

The slope term shown in brackets simplifies to -59.2 mV/decade at 25°C. It can be adjusted by user calibration to adjust for aging and other physical factors of the electrodes, and also depends on temperature.

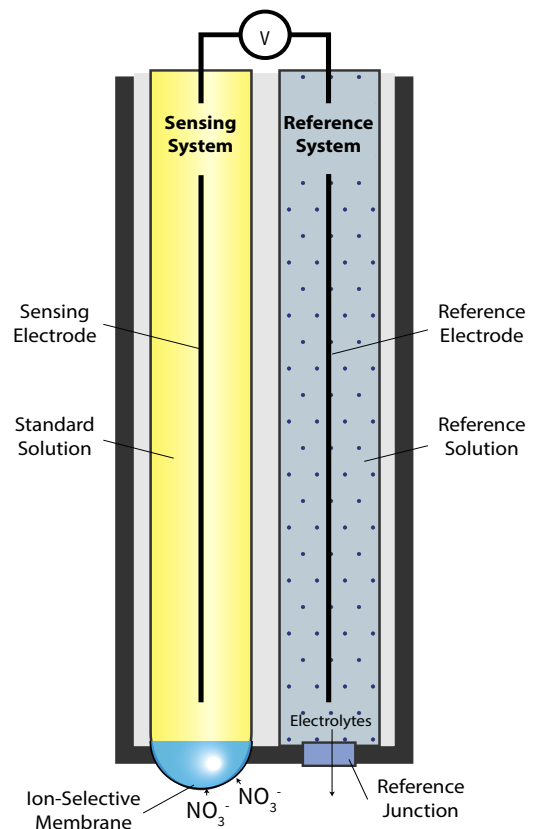

## Potential Interferents

Nitrate ISE sensors select for nitrate ions based on size and charge. They are subject to interference from other anions and are not well suited to brackish or ocean environments. The table below lists concentrations of possible interfering ions that cause 10% error at various levels (in ppm) of  $\text{NO}_3^-$ .

ION	100 PPM $\text{NO}_3^-$	10 PPM $\text{NO}_3^-$	1 PPM $\text{NO}_3^-$
Perchlorate ( $\text{ClO}_4^-$ ) ppm	$7 \times 10^{-2}$	$7 \times 10^{-3}$	$7 \times 10^{-4}$
Iodide ( $\text{I}^-$ ) ppm	4	0.4	0.04
Chlorate ( $\text{ClO}_3^-$ ) ppm	30	3	0.3
Cyanide ( $\text{CN}^-$ ) ppm	20	2	0.2
Bromide ( $\text{Br}^-$ ) ppm	400	40	4
Nitrite ( $\text{NO}_2^-$ ) ppm	230	23	2
Hydrogen Sulfide ( $\text{HS}^-$ ) ppm	230	23	2
Bicarbonate ( $\text{HCO}_3^-$ ) ppm	440	440	44
Carbonate ( $\text{CO}_3^{2-}$ ) ppm	8,600	860	86
Chloride ( $\text{Cl}^-$ ) ppm	7,600	760	76
Dihydrogen Phosphate ( $\text{H}_2\text{PO}_4^-$ ) ppm	34,640	3,464	346
Hydrogen Phosphate ( $\text{HPO}_4^{2-}$ ) ppm	34,300	3,430	343
Phosphate ( $\text{PO}_4^{3-}$ ) ppm	33,900	3,390	339
Acetate ( $\text{OAc}^-$ ) ppm	104,200	10,420	1,042
Fluoride ( $\text{F}^-$ ) ppm	81,400	8,140	814
Sulfate ( $\text{SO}_4^{2-}$ ) ppm	685,700	68,570	6,857

## Additional Information

For more information about these parameters and their applications, visit [www.in-situ.com](http://www.in-situ.com).

For additional sensor details including accuracy, range, resolution, methodology, detection limits, response time, and more, see the Aqua TROLL Sensor Specification sheet at [www.in-situ.com](http://www.in-situ.com).

## Chemical Incompatibility



Do not store ISE sensors or pH sensors in DI water. It will deplete the reference solution and drastically reduce the life of the sensor.



Do not soak the sensor in strong solvents, such as chlorinated solvents, ethers, or ketones, such as acetone.

## Installation Requirements



ISE sensors require one or more additional sensors. You must install the required sensors described below.

### TO MEASURE NITRATE...

Nitrate measurements depend on temperature. To read nitrate, you must have ONE of the following sensors installed:

- Temperature Sensor OR Conductivity/Temperature Sensor

## Preparing Ion-Selective Electrode Sensors



Follow these steps before deploying your sensor for the first time or after long-term storage to ensure accurate data.



**1**

Replace the sensor fill solution (see instructions on the following pages).



**2**

Soak sensor for 2-24 hours in 140 mg/L calibration standard or the highest standard you plan to use, whichever is greater.



**3**

Apply grease to the O-rings and install the sensor in the instrument.



**4**

Calibrate the sensor with the VuSitu mobile app.

# Cleaning



Salt crystals may form on the sensor during shipping or storage. These are normal and will not interfere with sensor performance. Rinse with deionized water to remove any buildup.



Potential salt buildup. Rinse with deionized water if necessary.



If further cleaning is needed, clean the sensor based on the nature of the debris. Begin with the gentlest cleaning method and continue to the others only if necessary. Do not directly wipe the membrane.

## TO REMOVE CRYSTALLINE DEPOSITS:



1 Clean the sensor with warm water and mild soap.



2 Soak the sensor in 5% HCl solution for 10 to 30 minutes.



3 If deposits persist, alternate soaking in 5% HCl and 5% NaOH solutions.



4 Thoroughly rinse the sensor with deionized water.

## TO REMOVE OILY OR GREASY RESIDUE:



Do not soak the sensor in strong solvents, such as chlorinated solvents, ethers, or ketones, such as acetone.



1 Clean the sensor with warm water and mild soap.

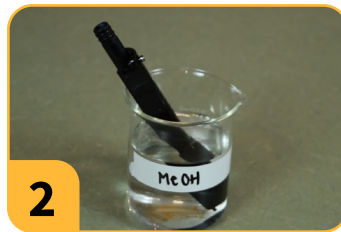

2 Soak the sensor in methanol or isopropyl alcohol for up to 1 hour.



3 Thoroughly rinse the sensor with deionized water.

## TO REMOVE PROTEIN-LIKE MATERIAL, OR SLIMY FILM:



1 Clean the sensor with warm water and mild soap.

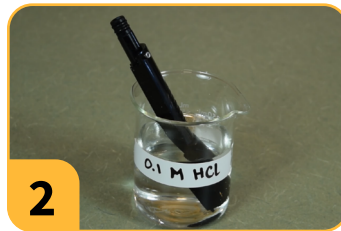

2 Soak the sensor in 0.1 M HCl solution for 10 minutes.



3 Thoroughly rinse the sensor with deionized water.

# Recommended Calibration Frequency

Requirements for calibration can range from daily to monthly or even longer depending on your program needs and deployment conditions. Deployment environments with low ion concentration, wide temperature fluctuations, high temperatures, or fouling will require more frequent cleaning and calibration.

Prior to calibration, clean the sensor and insert it into a known calibration standard to determine if the sensor is reading within the accuracy range required for your application. If the readings are outside of the accuracy range, you may need to calibrate more frequently for your site conditions.

## Calibration Procedure



For best results, perform at least a two-point calibration. Use the calibration standards closest to your expected deployment conditions.



Do not attempt to calibrate a pH or ISE sensor with DI water. Ions in the calibration solution are required for accurate calibration.



You can batch calibrate a group of nitrate sensors at the same time to reduce time and calibration solution. Always make sure you have a temperature sensor installed during calibration.

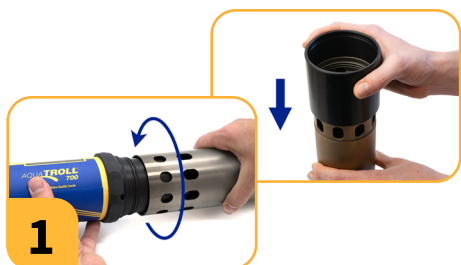

1 Place the restrictor in calibration mode (holes near the center of the instrument). If you are using a copper restrictor, install the calibration sleeve.

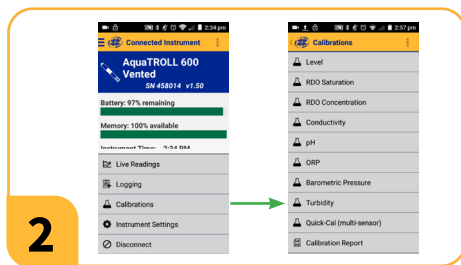

2 In VuSitu, click Calibrations from the Connected Instrument screen and choose sensor to calibrate.



3 Remove cap from instrument and pour DI water into restrictor. Use 10-20 mL for Aqua TROLL 500 or 600. Use 20-40 mL for Aqua TROLL 700 or 800.



4 Gently shake the sonde in a circular motion to rinse the inside of restrictor and sensors. Discard the DI water and repeat rinsing procedure two more times with your first calibration standard.



5 Pour calibration solution into the restrictor to a depth of 1 cm above the sensor faces. Cover the restrictor with the end cap.

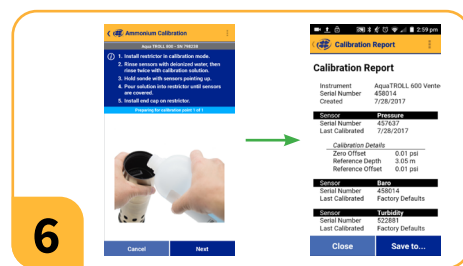

6 Follow the instructions in VuSitu to start the calibration.

## Checking Calibration Quality



After calibration, check these indicators in the VuSitu Calibration Report. If you are logged in, Calibration Reports will automatically upload to HydroVu for secure storage and access from any device.

INDICATOR	ACCEPTABLE RANGE	NOTES
Slope	< -20 mV/decade	Theoretically ideal slope: -59.2 mV/decade
14 mg/L Standard	95.6 ±30 mV	Use the standard closest to expected deployment conditions
140 mg/L Standard	39.8 ±30 mV	Use the standard closest to expected deployment conditions
1400 mg/L Standard	-16.2 ±30 mV	Use the standard closest to expected deployment conditions

If the values are outside of the ranges listed above, follow these troubleshooting steps. Then try the calibration again.

- Thoroughly clean, rinse, and dry the sensor, restrictor, and calibration equipment.
- Make sure you are using enough calibration solution as described in the calibration procedure in this manual.
- Check that calibration solutions are not expired.
- Follow the instructions to replace the sensor fill solution. If the calibration still fails, replace the reference junction.
- Check that the fill solution chamber is completely filled with no air bubbles.
- From Instrument Settings, select Restore Calibration Defaults. Then try calibrating again.
- Make sure the sensor has been stored properly according to the instructions in this manual.
- Check whether the sensor is reaching the end of its expected life. It may be time to replace your sensor.

## Shelf Life for In-Situ Solutions

SOLUTION	SHELF LIFE - UNOPENED	SHELF LIFE - OPENED
Nitrate Standard as N (available in 14, 140, 1400 mg/L)	12 months	3 to 6 months
Deionized Water	24 months	Hours, check before use for calibration
Sensor Reference Filling Solution	24 months	12 months
Storage Solution	24 months	12 months

## Expected Sensor Life

Follow all storage, cleaning and maintenance recommendations to maximize the life of your sensor. A well-maintained sensor can last 6-12 months (total shelf and deployment lifetime from the date of manufacture) depending on site and storage conditions. The lifetime may be reduced if the instrument is installed in abrasive or corrosive conditions, stored or cleaned improperly, or deployed outside of its operational temperature and pressure ranges.

# Replacing the Sensor Fill Solution and Reference Junction

The sensor fill solution has a shelf life of 2 years. Replace the fill solution every 5 to 6 months or when:

1. The sensor fails to calibrate within the acceptable slope or standard mV ranges.
2. Sensor readings vary or are slow to respond.
3. Readings in a known standard are outside the accuracy range for the sensor.

If the sensor still fails to calibrate after replacing the fill solution, replace the reference junction.



Follow the procedure below to replace the sensor fill solution and/or the reference junction.



**1** Remove sensor from sonde and unscrew reference junction.



**2** Don't dump solution down the drain. Pour it onto a paper towel and discard.



**3** Lightly shake the bottle of reference filling solution to mix.



**4** Insert the fill tube into the bottom of reservoir.



**5** Squeeze a steady stream of solution into the reservoir while slowly pulling out the tube.



**6** Overfill slightly. Reinstall the reference junction and tighten until it touches sensor body. Turn 90° more to secure.



**7** Soak sensor for 2-24 hours in 140 mg/L calibration standard or the highest standard you plan to use, whichever is greater.



**8** Rinse the sensor thoroughly. Reinstall the sensor in the instrument and calibrate with VuSitu.

## Storage



Do not store the pH/ORP sensor or ISE sensors in DI water. It will deplete the reference solution and drastically reduce the life of the sensor.



**1** Dampen the storage cap sponge with Storage Solution.



**2** Place the cap with the sponge on the sensor.



**3** Use electrical tape to seal the storage cap.



**4** Place a dust cover over the sensor connector.



ISE sensors require maintenance after long-term storage to properly measure data. Follow the instructions under Preparing Ion-Selective Electrode Sensors before deploying the sensor.

# Chloride Sensor

## About the Sensor

The In-Situ Chloride Ion-Selective Electrode (ISE) Sensor measures chloride levels in natural water, surface water, groundwater, produced water and aquaculture applications.



## How It Works

In-Situ chloride sensors are solid state ion-selective electrodes (ISEs). Chloride ions interact with a membrane that is selective based on ion charge and size. As ions interact with the membrane, a potential difference develops due to the concentration difference of chloride ions in the solution and those within the membrane. A separate reference system maintains a consistent electric potential regardless of changes in chloride outside the sensor. In-Situ chloride sensors include both the chloride electrode and reference electrode as half-cells in one unit.

The reference system consists of a silver wire coated in silver chloride in a mixed potassium chloride/silver chloride (KCl/AgCl) solution. The reference junction is porous to allow electrolytes to slowly diffuse out and maintain electrical contact with the sample. Like all ISEs, the necessity of the porous junction and slow leakage of the reference solution gives the sensor a relatively short lifespan. Errors or drift in chloride readings are usually due to issues with the reference solution or junction. Regularly refilling the reference solution and replacing the junction will significantly extend the sensor's life. Eventually the membrane becomes ineffective, and the sensor will need to be replaced.

Chloride concentration is calculated with the Nernst equation:

$$E_{cell} = E^0 - \left[ 2.3 \frac{RT}{nF} \right] \log(Q)$$

Where:

- $E_{cell}$  = potential of the sensing electrode
- $E^0$  = potential of the reference electrode
- R = Gas Law constant
- T = temperature (in Kelvin)
- n = ionic charge (for Cl<sup>-</sup>, n = -1)
- F = Faraday's constant
- Q = Reaction quotient

The slope term shown in brackets simplifies to -59.2 mV/decade at 25°C. It can be adjusted by user calibration to adjust for aging and other physical factors of the electrodes, and also depends on temperature.

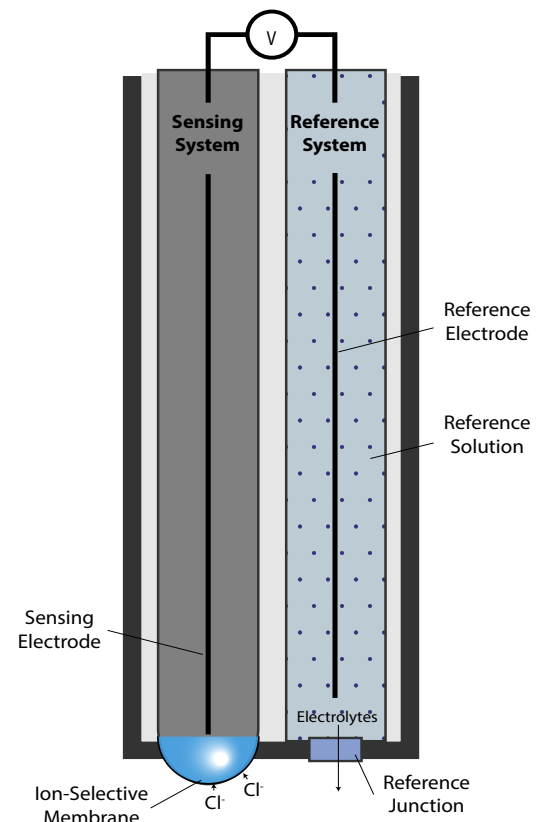

## Potential Interferents

Chloride ISE sensors select for chloride ions based on size and charge. They are subject to interference from other anions and are not well suited to brackish or ocean environments. The table below lists concentrations of possible interfering ions that cause 10% error at various levels (in ppm) of Cl<sup>-</sup>.

ION	100 PPM CL <sup>-</sup>	10 PPM CL <sup>-</sup>	1 PPM CL <sup>-</sup>
Hydroxide (OH <sup>-</sup> ) ppm	3,840	384	38.4
Ammonia (NH <sub>3</sub> ) ppm	6	0.6	0.06
Thiosulfate (S <sub>2</sub> O <sub>3</sub> <sup>2-</sup> ) ppm	3	0.3	0.03
Bromide (Br <sup>-</sup> ) ppm	0.68	0.068	6.8 x 10 <sup>-3</sup>
Sulfide (S <sup>2-</sup> ) ppm	9 x 10 <sup>-5</sup>	9 x 10 <sup>-6</sup>	9 x 10 <sup>-7</sup>
Iodide (I <sup>-</sup> ) ppm	1.8 x 10 <sup>-4</sup>	1.8 x 10 <sup>-5</sup>	1.8 x 10 <sup>-6</sup>
Cyanide (CN <sup>-</sup> ) ppm	1.5 x 10 <sup>-5</sup>	1.5 x 10 <sup>-6</sup>	1.5 x 10 <sup>-7</sup>

## Additional Information

For more information about these parameters and their applications, visit [www.in-situ.com](http://www.in-situ.com).

For additional sensor details including accuracy, range, resolution, methodology, detection limits, response time, and more, see the Aqua TROLL Sensor Specification sheet at [www.in-situ.com](http://www.in-situ.com).

## Chemical Incompatibility



Do not store ISE sensors or pH sensors in DI water. It will deplete the reference solution and drastically reduce the life of the sensor.



Do not soak the sensor in strong solvents, such as chlorinated solvents, ethers, or ketones, such as acetone.

## Installation Requirements



ISE sensors require one or more additional sensors. You must install the required sensors described below.

### TO MEASURE CHLORIDE...

Chloride measurements depend on temperature. To read chloride, you must have ONE of the following sensors installed:

- Temperature Sensor OR Conductivity/Temperature Sensor

## Preparing Ion-Selective Electrode Sensors



Follow these steps before deploying your sensor for the first time or after long-term storage to ensure accurate data.



**1**

Replace the sensor fill solution (see instructions on the following pages).



**2**

Soak sensor for 2-24 hours in the highest calibration standard you plan to use.



**3**

Apply grease to the O-rings and install the sensor in the instrument.



**4**

Calibrate the sensor with the VuSitu mobile app.

# Cleaning



Salt crystals may form on the sensor during shipping or storage. These are normal and will not interfere with sensor performance. Rinse with deionized water to remove any buildup.



Potential salt buildup. Rinse with deionized water if necessary.



If further cleaning is needed, clean the sensor based on the nature of the debris. Begin with the gentlest cleaning method and continue to the others only if necessary. Do not directly wipe the membrane.

## TO REMOVE CRYSTALLINE DEPOSITS:



1 Clean the sensor with warm water and mild soap.



2 Soak the sensor in 5% HCl solution for 10 to 30 minutes.

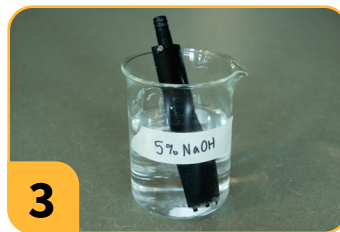

3 If deposits persist, alternate soaking in 5% HCl and 5% NaOH solutions.



4 Thoroughly rinse the sensor with deionized water.

## TO REMOVE OILY OR GREASY RESIDUE:



Do not soak the sensor in strong solvents, such as chlorinated solvents, ethers, or ketones, such as acetone.



1 Clean the sensor with warm water and mild soap.

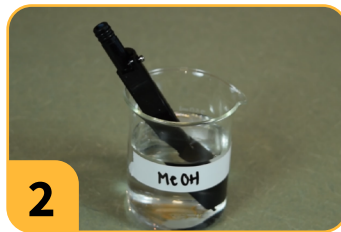

2 Soak the sensor in methanol or isopropyl alcohol for up to 1 hour.



3 Thoroughly rinse the sensor with deionized water.

## TO REMOVE PROTEIN-LIKE MATERIAL, OR SLIMY FILM:



1 Clean the sensor with warm water and mild soap.

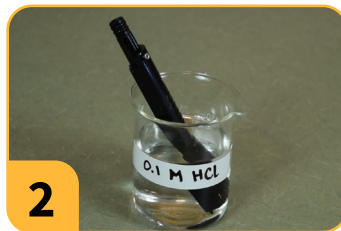

2 Soak the sensor in 0.1 M HCl solution for 10 minutes.



3 Thoroughly rinse the sensor with deionized water.

# Recommended Calibration Frequency

Requirements for calibration can range from daily to monthly or even longer depending on your program needs and deployment conditions. Deployment environments with low ion concentration, wide temperature fluctuations, high temperatures, or fouling will require more frequent cleaning and calibration.

Prior to calibration, clean the sensor and insert it into a known calibration standard to determine if the sensor is reading within the accuracy range required for your application. If the readings are outside of the accuracy range, you may need to calibrate more frequently for your site conditions.

## Calibration Procedure



For best results, perform at least a two-point calibration. Use the calibration standards closest to your expected deployment conditions.



Do not attempt to calibrate a pH or ISE sensor with DI water. Ions in the calibration solution are required for accurate calibration.



You can batch calibrate a group of chloride sensors at the same time to reduce time and calibration solution. Always make sure you have a temperature sensor installed during calibration.

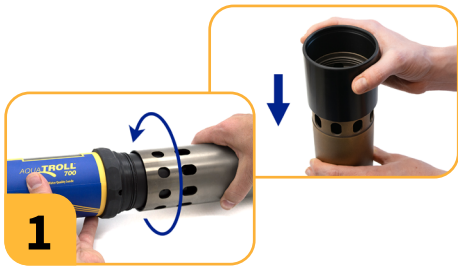

Place the restrictor in calibration mode (holes near the center of the instrument). If you are using a copper restrictor, install the calibration sleeve.

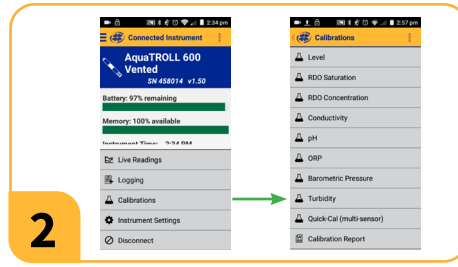

In VuSitu, click Calibrations from the Connected Instrument screen and choose sensor to calibrate.



Remove cap from instrument and pour DI water into restrictor. Use 10-20 mL for Aqua TROLL 500 or 600. Use 20-40 mL for Aqua TROLL 700 or 800.



Gently shake the sonde in a circular motion to rinse the inside of restrictor and sensors. Discard the DI water and repeat rinsing procedure two more times with your first calibration standard.



Pour calibration solution into the restrictor to a depth of 1 cm above the sensor faces. Cover the restrictor with the end cap.



Follow the instructions in VuSitu to start the calibration.

## Checking Calibration Quality



After calibration, check these indicators in the VuSitu Calibration Report. If you are logged in, Calibration Reports will automatically upload to HydroVu for secure storage and access from any device.

INDICATOR	ACCEPTABLE RANGE	NOTES
Slope	< -20 mV/decade	Theoretically ideal slope: -59.2 mV/decade
35.5 mg/L Standard	199.1 ±30 mV	Use the standard closest to expected deployment conditions
355 mg/L Standard	143.2 ±30 mV	Use the standard closest to expected deployment conditions
3545 mg/L Standard	87.2 ±30 mV	Use the standard closest to expected deployment conditions

If the values are outside of the ranges listed above, follow these troubleshooting steps. Then try the calibration again.

- Thoroughly clean, rinse, and dry the sensor, restrictor, and calibration equipment.
- Make sure you are using enough calibration solution as described in the calibration procedure in this manual.
- Check that calibration solutions are not expired.
- Follow the instructions to replace the sensor fill solution. If the calibration still fails, replace the reference junction.
- Check that the fill solution chamber is completely filled with no air bubbles.
- From Instrument Settings, select Restore Calibration Defaults. Then try calibrating again.
- Make sure the sensor has been stored properly according to the instructions in this manual.
- Check whether the sensor is reaching the end of its expected life. It may be time to replace your sensor.

## Shelf Life for In-Situ Solutions

SOLUTION	SHELF LIFE - UNOPENED	SHELF LIFE - OPENED
Chloride Standard (available in 35.5, 355, 3545 mg/L)	12 months	3 to 6 months
Deionized Water	24 months	Hours, check before use for calibration
Sensor Reference Filling Solution	24 months	12 months
Storage Solution	24 months	12 months

## Expected Sensor Life

Follow all storage, cleaning and maintenance recommendations to maximize the life of your sensor. A well-maintained sensor can last a year or longer (total shelf and deployment lifetime from the date of manufacture) depending on site and storage conditions. The lifetime may be reduced if the instrument is installed in abrasive or corrosive conditions, stored or cleaned improperly, or deployed outside of its operational temperature and pressure ranges.

# Replacing the Sensor Fill Solution and Reference Junction

The sensor fill solution has a shelf life of 2 years. Replace the fill solution every 5 to 6 months or when:

1. The sensor fails to calibrate within the acceptable slope or standard mV ranges.
2. Sensor readings vary or are slow to respond.
3. Readings in a known standard are outside the accuracy range for the sensor.

If the sensor still fails to calibrate after replacing the fill solution, replace the reference junction.



Follow the procedure below to replace the sensor fill solution and/or the reference junction.



**1** Remove sensor from sonde and unscrew reference junction.



**2** Don't dump solution down the drain. Pour it onto a paper towel and discard.



**3** Lightly shake the bottle of reference filling solution to mix.



**4** Insert the fill tube into the bottom of reservoir.



**5** Squeeze a steady stream of solution into the reservoir while slowly pulling out the tube.



**6** Overfill slightly. Reinstall the reference junction and tighten until it touches sensor body. Turn 90° more to secure.



**7** Soak sensor for 2-24 hours in the highest calibration standard you plan to use, whichever is greater.



**8** Rinse the sensor thoroughly. Reinstall the sensor in the instrument and calibrate with VuSitu.

## Storage



Do not store the pH/ORP sensor or ISE sensors in DI water. It will deplete the reference solution and drastically reduce the life of the sensor.



**1** Dampen the storage cap sponge with Storage Solution.



**2** Place the cap with the sponge on the sensor.



**3** Use electrical tape to seal the storage cap.



**4** Place a dust cover over the sensor connector.



ISE sensors require maintenance after long-term storage to properly measure data. Follow the instructions under Preparing Ion-Selective Electrode Sensors before deploying the sensor.

# Chlorophyll a Sensor

## About the Sensor

This sensor uses fluorescence to measure Chlorophyll a. The sensor includes integrated optical compensation to compensate for LED drift over temperature and time and isolated optical frequencies to minimize interference and improve accuracy.



## How It Works

Chlorophyll a sensors are fluorometers. Many molecules can absorb light from a specific spectrum and then emit light at a different wavelength in a process known as fluorescence. Fluorometers are optical instruments that measure the fluorescence of substances in water.

These fluorescent molecules are detected using a carefully designed system. An LED emitter generates light at a specific wavelength, and filters isolate the desired excitation spectrum. When this light reaches fluorescent molecules in a water sample, they absorb the energy and emit light at a longer wavelength (lower energy). This emitted light is known as the fluorescence signature.

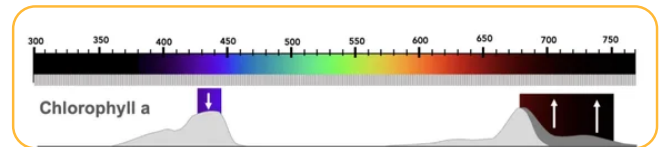

The sensor's detector, equipped with its own set of filters, captures the emitted light and measures its intensity. Because fluorescence intensity is proportional to the concentration of fluorescent molecules, the sensor can estimate the concentration of target substances in the water. As concentration increases, more molecules absorb the excitation light, typically resulting in stronger fluorescence.

Measurements are typically expressed in Relative Fluorescence Units (RFUs). RFUs indicate relative changes in concentration of the fluorescent substance, but they do not provide an exact concentration without a site-specific correlation.

In-Situ fluorometers also include a reference detector for Integrated Optical Compensation. This reference detector measures changes in LED brightness and automatically adjusts each reading to compensate for variations caused by temperature or age of the sensor.

Aqua TROLL fluorometers run at unique spectral bands and are filtered with an LED frequency signature to optimize performance. This significantly reduces the effects of ambient lighting conditions and other optical sensors installed in the instrument.

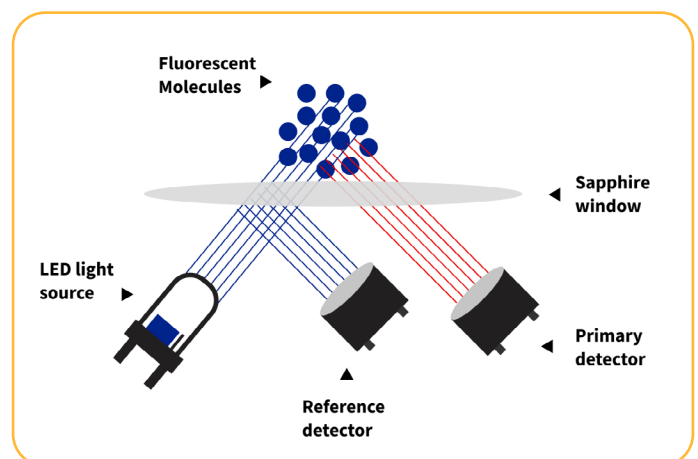

## Potential Interferents

All optical sensors experience interference from turbidity. High turbidity can interrupt a clear path for light to travel to and from the sensor. The same cells that are producing chlorophyll may also increase the turbidity of the water. Thus, the relationship between turbidity and the target parameter is complex. It is not always linear and can be influenced by different particle types.

In all cases, however, turbidity is most likely to lead to an underestimation of the target parameter. Best practice is to always measure turbidity alongside any fluorescence measurement. At the very least, this enables an awareness of possible turbidity interference. In some cases, turbidity measurements can help develop a mathematical correction for turbidity interference. The threshold at which turbidity interference occurs, in either nephelometric turbidity units (NTUs) or formazin nephelometric units (FNU), depends on both the monitoring site and project objectives. Any turbidity corrections must be developed empirically from site-specific measurements.

## Fluorescence Wavelengths

SENSOR	EXCITATION WAVELENGTH (NOMINAL)	DETECTION WAVELENGTH
Chlorophyll a	430 nm	675 nm to 750 nm

## Derived Parameters: Cell Count and Concentration



To find the scale factor, start by determining the cell count or concentration. Then divide the cell count or concentration by the RFU reading: **Scale factor = Concentration or Cell Count ÷ Fluorescence (in RFU)**

There are several different types of chlorophyll, and photosynthetic organisms will often have 2 or more types of chlorophyll in their chloroplasts. Nearly all organisms that rely on photosynthesis, such as eukaryotes (algae), cyanobacteria, and prochlorophytes (bacteria and planktons) contain chlorophyll a. Changes in chlorophyll a fluorescence in a body of water can therefore be used to monitor relative changes in algae or other photosynthetic organisms. The instrument can derive an estimate for Cell Count (default cells/mL) and Concentration (default µg/L) based on a linear correlation with the Relative Fluorescence measured by the sensor.

The relationship between relative fluorescence and these derived parameters varies highly for each deployment site. The amount of light fluoresced varies by species. Species vary by size, shape, number of chloroplasts and types of accessory pigments, all of which can affect light output. The cell walls and other cellular structures can alter the path of light into or out of the cell. Chlorophyll is actively involved in biological processes within cells which can affect how much light is fluoresced. The amount of light fluoresced by any individual organism varies by the age, health, environment and past light history of that individual. Because of these variable characteristics, the correlation of RFU to concentration or cell count needs to be determined empirically for each specific deployment site.

You can enable derived parameters and enter a linear scale factor for your deployment site based on laboratory analysis of grab samples. Once you have determined the cell count or concentration and calculated the scale factor, you can input the scale factor in VuSitu under **Instrument Settings > Derived Parameters**. An example calculation is shown below for reference.

$$\underbrace{54.8 \text{ RFU}}_{\text{FLUORESCENCE}} * \underbrace{1.248}_{\text{SCALE FACTOR}} = \underbrace{68.4 \text{ mg/L}}_{\text{DERIVED CONCENTRATION}}$$

## Additional Information

For additional sensor details including accuracy, range, resolution, methodology, detection limits, response time, and more, see the Aqua TROLL sensor specification sheet at [www.in-situ.com](http://www.in-situ.com).

For more information about this parameter including application information, parameter calculation equations, sensor design, and more, view the parameter page at [www.in-situ.com](http://www.in-situ.com).

## Installation Requirements



Fluorometers do not require special preparation. Apply a thin layer of grease to the connector O-rings before installing any sensor in the instrument.



Use caution when deploying in direct sunlight or environments with highly-reflective surfaces. Although the sensor's filters reduce the effects of ambient light, very high light levels can interfere with readings.

## Chemical Incompatibility



Do not soak the sensor in solvents, such as chlorinated solvents, ethers, or ketones, such as acetone. Do not use metal scraping tools to clean the sensor. Follow the cleaning procedure described below.

## Cleaning



Rinse the sensor face with clean, cold water. If further cleaning is needed, clean the sensor based on the nature of the debris. Begin with the gentlest method and continue to the others only if necessary.

### TO REMOVE SOFT FOULING:



1 Clean the sensor with warm water and mild soap.



2 Soak the sensor in dish soap and warm water.



3 Use a soft brush to gently clean all debris from the optical window.



4 Thoroughly rinse the sensor with deionized water.

### TO REMOVE HARD FOULING:



1 Clean the sensor with warm water and mild soap.



2 Soak the sensor in dilute vinegar.



3 Use a soft brush to gently clean all debris from the optical window.



4 Thoroughly rinse the sensor with deionized water.

## Recommended Calibration Frequency

Calibrating a fluorometer adjusts the relative fluorescence measured by the sensor by applying a slope and offset to the factory-calibrated values. In-Situ's sensors are rigorously calibrated in our factory across their full range and maintain linear fluorescence readings without need for user calibration. To translate fluorescence readings into more meaningful measurements like concentration or cell count, see the above sections for each of these derived parameters.

You can calibrate the sensor to compensate for physical changes to the lens or if you have Standard Operating Procedures that require calibration. Choose **Restore Calibration Defaults** from **Instrument Settings** to return to the last factory calibration.

Calibrate the Chlorophyll a sensor using one of three methods:

1. **Deionized Water:** Reset the zero point by performing a calibration in deionized water.
2. **Rhodamine Standard:** Calibrate with a Rhodamine WT standard to adjust readings of higher concentrations based on known equivalency. See the instructions on the next page to prepare a Rhodamine WT standard.
3. **Custom Standard or Reference:** Use a reference or a custom calibration standard.

## Calibration Procedure



Fluorometers require more calibration solution than other solution-based calibrations. If solution-based calibration is required, pour solution all the way to the bottom of the restrictor threads.

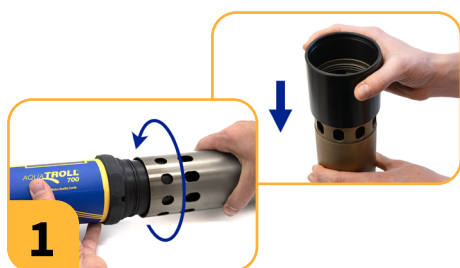

Place the restrictor in calibration mode (holes near the center of the instrument). If you are using a copper restrictor, install the calibration sleeve.

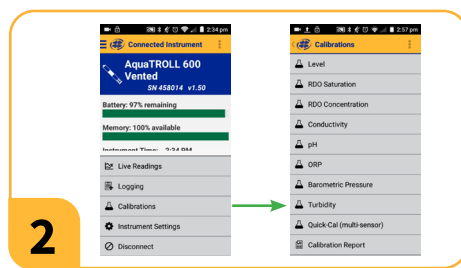

In VuSitu, click Calibrations from the Connected Instrument screen and choose sensor to calibrate.



Remove cap from instrument and pour DI water into restrictor. Use 10-20 mL for Aqua TROLL 500 or 600. Use 20-40 mL for Aqua TROLL 700 or 800.



Gently shake the sonde in a circular motion to rinse the inside of restrictor and sensors, then discard the DI water. Because fluorescence is an optical measurement, rinsing with calibration solution is not necessary.



Pour calibration solution into the restrictor up to the bottom of the threads. Cover the restrictor with the end cap.



Follow the instructions in VuSitu to start the calibration.

# Preparing Rhodamine WT Calibration Standard



**1** Start with a 2.5% Rhodamine WT solution. Pipette 1.0 mL of the solution into a 250 mL Class A volumetric flask.



**2** Bring the flask to volume with deionized water. The resulting solution is 100 mg/L Rhodamine WT.



**3** To obtain a 500 µg/L concentration, pipette 5 mL of the 100 mg/L solution into a 1000 mL flask.



**4** Bring the flask to volume with deionized water.



Use an opaque container to store the 100 mg/L solution in a cool, dark place for up to six months. If desired, use the procedure described above to make a different concentration of Rhodamine WT, such as 1000 µg/L. Alter the volume in Step 3 according to the table below to achieve the target concentration. Prepare the dilutions immediately before use and discard after calibration.

TARGET CONCENTRATION	100 MG/L RHODAMINE WT	EXPECTED RFU VALUE AT 25° C
0 µg/L (deionized water)	none	0
500 µg/L	5 mL	2.9
1,000 µg/L	10 mL	5.4

\* These values are for reference only. Actual values may vary based on user-prepared standards.

## Checking Calibration Quality



After calibration, check these indicators in the VuSitu Calibration Report. If you are logged in, Calibration Reports will automatically upload to HydroVu for secure storage and access from any device.

INDICATOR	ACCEPTABLE RANGE	NOTES
Slope	0.7 to 1.3	A sensor at factory defaults will have a slope of 1.

If the values are outside of the ranges listed above, follow these troubleshooting steps. Then try the calibration again.

- Thoroughly clean, rinse, and dry the sensor, restrictor, and calibration equipment.
- Make sure you are using enough calibration solution as described in the calibration procedure in this manual. Always cover the restrictor with the end cap during calibration.
- Check that calibration solutions are not expired.
- From **Instrument Settings**, select **Restore Calibration Defaults**. Then try calibrating again.
- Inspect the lenses for scratches, smudges, or condensation inside the sensor. If you notice major scratches or internal condensation and the sensor is not calibrating properly, you may need to replace your sensor.
- Make sure the sensor has been stored properly according to the instructions in this manual.
- Check whether the sensor is reaching the end of its expected life. It may be time to replace your sensor.

## Shelf Life for In-Situ Solutions

SOLUTION	SHELF LIFE - UNOPENED	SHELF LIFE - OPENED
Deionized Water	24 months	Hours, check before use for calibration

## Maintenance



Fluorometers do not have unique maintenance requirements aside from cleaning as described in this manual. Change the connector O-rings as part of routine instrument maintenance.

## Storage



Fluorometers do not have any unique storage requirements. They can be stored wet or dry. Cover the connector with the included dust cover when it is not in use to protect the connector from corrosion or fouling.

## Expected Sensor Life

Follow all recommendations in this manual to maximize the life of your sensor. Fluorometers can last years depending on site and storage conditions. The lifetime may be reduced if the instrument is installed in abrasive or corrosive conditions, cleaned improperly, or deployed outside of its operational temperature and pressure ranges.

# BGA-PC Sensor

## About the Sensor

This sensor uses fluorescence to measure BGA-PC. The sensor includes integrated optical compensation to compensate for LED drift over temperature and time and isolated optical frequencies to minimize interference and improve accuracy.



## How It Works

BGA-PC sensors are fluorometers. Many molecules can absorb light from a specific spectrum and then emit light at a different wavelength in a process known as fluorescence. Fluorometers are optical instruments that measure the fluorescence of substances in water.

These fluorescent molecules are detected using a carefully designed system. An LED emitter generates light at a specific wavelength, and filters isolate the desired excitation spectrum. When this light reaches fluorescent molecules in a water sample, they absorb the energy and emit light at a longer wavelength (lower energy). This emitted light is known as the fluorescence signature.

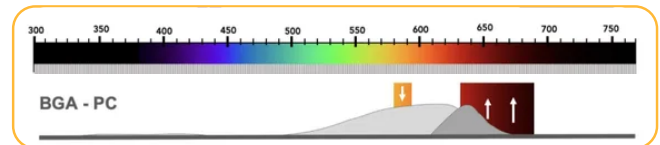

The sensor's detector, equipped with its own set of filters, captures the emitted light and measures its intensity. Because fluorescence intensity is proportional to the concentration of fluorescent molecules, the sensor can estimate the concentration of target substances in the water. As concentration increases, more molecules absorb the excitation light, typically resulting in stronger fluorescence.

Measurements are typically expressed in Relative Fluorescence Units (RFUs). RFUs indicate relative changes in concentration of the fluorescent substance, but they do not provide an exact concentration without a site-specific correlation.

In-Situ fluorometers also include a reference detector for Integrated Optical Compensation. This reference detector measures changes in LED brightness and automatically adjusts each reading to compensate for variations caused by temperature or age of the sensor.

Aqua TROLL fluorometers run at unique spectral bands and are filtered with an LED frequency signature to optimize performance. This significantly reduces the effects of ambient lighting conditions and other optical sensors installed in the instrument.

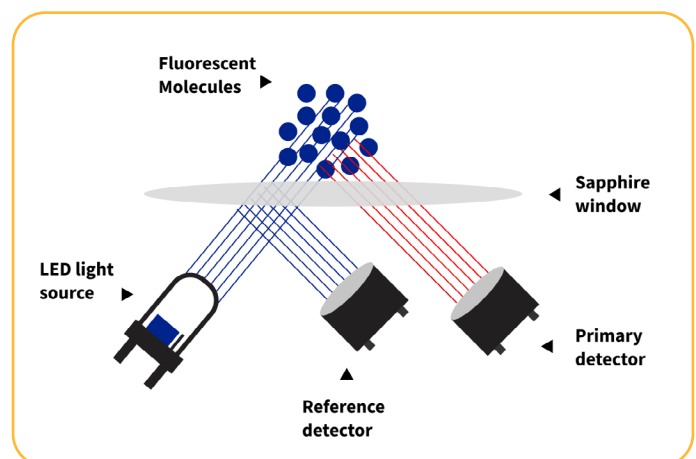

## Potential Interferents

All optical sensors experience interference from turbidity. High turbidity can interrupt a clear path for light to travel to and from the sensor. The same cells that are fluorescing may also increase the turbidity of the water. Thus, the relationship between turbidity and the target parameter is complex. It is not always linear and can be influenced by different particle types.

In all cases, however, turbidity is most likely to lead to an underestimation of the target parameter. Best practice is to always measure turbidity alongside any fluorescence measurement. At the very least, this enables an awareness of possible turbidity interference. In some cases, turbidity measurements can help develop a mathematical correction for turbidity interference. The threshold at which turbidity interference occurs, in either nephelometric turbidity units (NTUs) or formazin nephelometric units (FNU), depends on both the monitoring site and project objectives. Any turbidity corrections must be developed empirically from site-specific measurements.

## Fluorescence Wavelengths

SENSOR	EXCITATION WAVELENGTH (NOMINAL)	DETECTION WAVELENGTH
BGA-PC	590 nm	640 nm to 690 nm

## Derived Parameters: Cell Count and Concentration



To find the scale factor, start by determining the cell count or concentration. Then divide the cell count or concentration by the RFU reading: **Scale factor = Concentration or Cell Count ÷ Fluorescence (in RFU)**

Phycocyanin (PC) is an accessory pigment produced primarily by freshwater cyanobacteria, also known as blue-green algae. PC containing organisms are generally found at shallower depths and absorb redder light (imparting the blue-green color). An organism containing PC will also have Chlorophyll-a and may contain other accessory pigments. The instrument can derive an estimate for Cell Count (default cells/mL) and Concentration (default µg/L) based on a linear correlation with the Relative Fluorescence of PC measured by the sensor.

The relationship between relative fluorescence and these derived parameters varies highly for each deployment site. The amount of light fluoresced varies by species. Species vary by size, shape, and types of accessory pigments, all of which can affect light output. The cell walls and other cellular structures can alter the path of light into or out of the cell. Phycocyanin is actively involved in biological processes within cells which can affect how much light is fluoresced. The amount of light fluoresced by any individual organism varies by the age, health, environment and past light history of that individual. Because of these variable characteristics, the correlation of RFU to concentration or cell count needs to be determined empirically for each specific deployment site.

You can enable derived parameters and enter a linear scale factor for your deployment site based on laboratory analysis of grab samples. Once you have determined the cell count or concentration and calculated the scale factor, you can input the scale factor in VuSitu under **Instrument Settings > Derived Parameters**. An example calculation is shown below for reference.

$$\underbrace{54.8 \text{ RFU}}_{\text{FLUORESCENCE}} * \underbrace{1.248}_{\text{SCALE FACTOR}} = \underbrace{68.4 \text{ mg/L}}_{\text{DERIVED CONCENTRATION}}$$

## Additional Information

For additional sensor details including accuracy, range, resolution, methodology, detection limits, response time, and more, see the Aqua TROLL sensor specification sheet at [www.in-situ.com](http://www.in-situ.com).

For more information about this parameter including application information, parameter calculation equations, sensor design, and more, view the parameter page at [www.in-situ.com](http://www.in-situ.com).

## Installation Requirements



Fluorimeters do not require special preparation. Apply a thin layer of grease to the connector O-rings before installing any sensor in the instrument.



Use caution when deploying in direct sunlight or environments with highly-reflective surfaces. Although the sensor's filters reduce the effects of ambient light, very high light levels can interfere with readings.



When using BGA-PC and BGA-PE sensors together in an Aqua TROLL 500 or 600, install in non-adjacent sensor ports. This is not necessary for an Aqua TROLL 700 or 800.

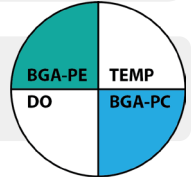

## Chemical Incompatibility



Do not soak the sensor in solvents, such as chlorinated solvents, ethers, or ketones, such as acetone. Do not use metal scraping tools to clean the sensor. Follow the cleaning procedure described below.

## Cleaning



Rinse the sensor face with clean, cold water. If further cleaning is needed, clean the sensor based on the nature of the debris. Begin with the gentlest method and continue to the others only if necessary.

### TO REMOVE SOFT FOULING:



1 Clean the sensor with warm water and mild soap.



2 Soak the sensor in dish soap and warm water.



3 Use a soft brush to gently clean all debris from the optical window.

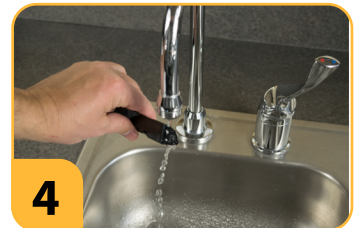

4 Thoroughly rinse the sensor with deionized water.

### TO REMOVE HARD FOULING:



1 Clean the sensor with warm water and mild soap.



2 Soak the sensor in dilute vinegar.



3 Use a soft brush to gently clean all debris from the optical window.



4 Thoroughly rinse the sensor with deionized water.

## Recommended Calibration Frequency

Calibrating a fluorometer adjusts the relative fluorescence measured by the sensor by applying a slope and offset to the factory-calibrated values. In-Situ's sensors are rigorously calibrated in our factory across their full range and maintain linear fluorescence readings without need for user calibration. To translate fluorescence readings into more meaningful measurements like concentration or cell count, see the above sections for each of these derived parameters.

You can calibrate the sensor to compensate for physical changes to the lens or if you have Standard Operating Procedures that require calibration. Choose **Restore Calibration Defaults** from **Instrument Settings** to return to the last factory calibration.

Calibrate the BGA-PC sensor using one of three methods:

1. **Deionized Water:** Reset the zero point by performing a calibration in deionized water.
2. **Rhodamine Standard:** Calibrate with a Rhodamine WT standard to adjust readings of higher concentrations based on known equivalency. See the instructions on the next page to prepare a Rhodamine WT standard.
3. **Custom Standard or Reference:** Use a reference or a custom calibration standard.

## Calibration Procedure



Fluorometers require more calibration solution than other solution-based calibrations. If solution-based calibration is required, pour solution all the way to the bottom of the restrictor threads.

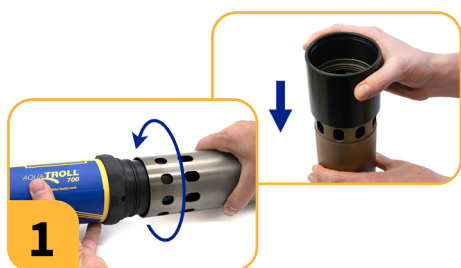

Place the restrictor in calibration mode (holes near the center of the instrument). If you are using a copper restrictor, install the calibration sleeve.

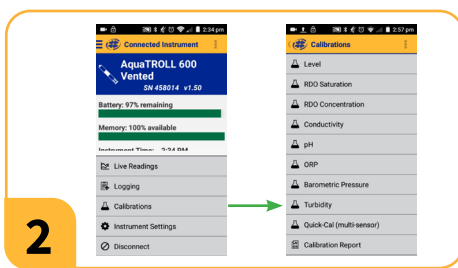

In VuSitu, click Calibrations from the Connected Instrument screen and choose sensor to calibrate.



Remove cap from instrument and pour DI water into restrictor. Use 10-20 mL for Aqua TROLL 500 or 600. Use 20-40 mL for Aqua TROLL 700 or 800.



Gently shake the sonde in a circular motion to rinse the inside of restrictor and sensors, then discard the DI water. Because fluorescence is an optical measurement, rinsing with calibration solution is not necessary.



Pour calibration solution into the restrictor up to the bottom of the threads. Cover the restrictor with the end cap.

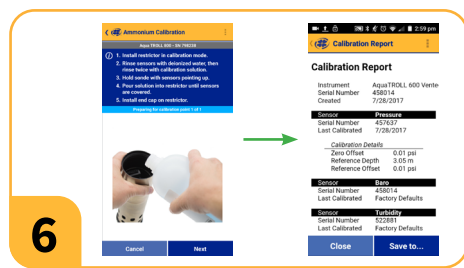

Follow the instructions in VuSitu to start the calibration.

## Preparing Rhodamine WT Calibration Standard

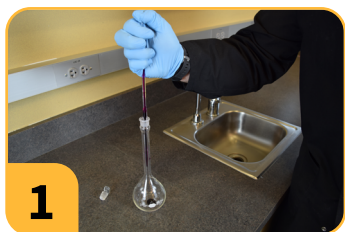

**1** Start with a 2.5% Rhodamine WT solution. Pipette 1.0 mL of the solution into a 250 mL Class A volumetric flask.



**2** Bring the flask to volume with deionized water. The resulting solution is 100 mg/L Rhodamine WT.



**3** To obtain a 200  $\mu\text{g/L}$  concentration, pipette 2.0 mL of the 100 mg/L solution into a 1000 mL flask.



**4** Bring the flask to volume with deionized water.



Use an opaque container to store the 200 mg/L solution in a cool, dark place for up to six months. If desired, use the procedure described above to make a different concentration of Rhodamine WT, such as 400  $\mu\text{g/L}$ . Alter the volume in Step 3 according to the table below to achieve the target concentration. Prepare the dilutions immediately before use and discard after calibration.

TARGET CONCENTRATION	100 MG/L RHODAMINE WT	EXPECTED RFU VALUE AT 25° C
0 $\mu\text{g/L}$ (deionized water)	none	0
100 $\mu\text{g/L}$	1.0 mL	8
200 $\mu\text{g/L}$	2.0 mL	16
400 $\mu\text{g/L}$	4.0 mL	31

\* These values are for reference only. Actual values may vary based on user-prepared standards.

## Checking Calibration Quality



After calibration, check these indicators in the VuSitu Calibration Report. If you are logged in, Calibration Reports will automatically upload to HydroVu for secure storage and access from any device.

INDICATOR	ACCEPTABLE RANGE	NOTES
Slope	0.7 to 1.3	A sensor at factory defaults will have a slope of 1.

If the values are outside of the ranges listed above, follow these troubleshooting steps. Then try the calibration again.

- Thoroughly clean, rinse, and dry the sensor, restrictor, and calibration equipment.
- Make sure you are using enough calibration solution as described in the calibration procedure in this manual. Always cover the restrictor with the end cap during calibration.
- Check that calibration solutions are not expired.
- From **Instrument Settings**, select **Restore Calibration Defaults**. Then try calibrating again.
- Inspect the lenses for scratches, smudges, or condensation inside the sensor. If you notice major scratches or internal condensation and the sensor is not calibrating properly, you may need to replace your sensor.
- Make sure the sensor has been stored properly according to the instructions in this manual.
- Check whether the sensor is reaching the end of its expected life. It may be time to replace your sensor.

## Shelf Life for In-Situ Solutions

SOLUTION	SHELF LIFE - UNOPENED	SHELF LIFE - OPENED
Deionized Water	24 months	Hours, check before use for calibration

## Maintenance



Fluorometers do not have unique maintenance requirements aside from cleaning as described in this manual. Change the connector O-rings as part of routine instrument maintenance.

## Storage



Fluorometers do not have any unique storage requirements. They can be stored wet or dry. Cover the connector with the included dust cover when it is not in use to protect the connector from corrosion or fouling.

## Expected Sensor Life

Follow all recommendations in this manual to maximize the life of your sensor. Fluorometers can last years depending on site and storage conditions. The lifetime may be reduced if the instrument is installed in abrasive or corrosive conditions, cleaned improperly, or deployed outside of its operational temperature and pressure ranges.

# BGA-PE Sensor

## About the Sensor

This sensor uses fluorescence to measure BGA-PE. The sensor includes integrated optical compensation to compensate for LED drift over temperature and time and isolated optical frequencies to minimize interference and improve accuracy.



## How It Works

BGA-PE sensors are fluorometers. Many molecules can absorb light from a specific spectrum and then emit light at a different wavelength in a process known as fluorescence. Fluorometers are optical instruments that measure the fluorescence of substances in water.

These fluorescent molecules are detected using a carefully designed system. An LED emitter generates light at a specific wavelength, and filters isolate the desired excitation spectrum. When this light reaches fluorescent molecules in a water sample, they absorb the energy and emit light at a longer wavelength (lower energy). This emitted light is known as the fluorescence signature.

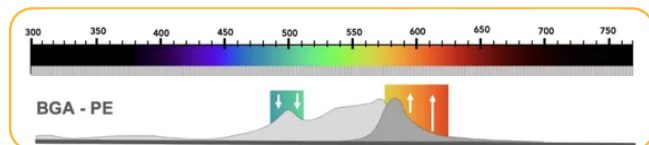

The sensor's detector, equipped with its own set of filters, captures the emitted light and measures its intensity. Because fluorescence intensity is proportional to the concentration of fluorescent molecules, the sensor can estimate the concentration of target substances in the water. As concentration increases, more molecules absorb the excitation light, typically resulting in stronger fluorescence.

Measurements are typically expressed in Relative Fluorescence Units (RFUs). RFUs indicate relative changes in concentration of the fluorescent substance, but they do not provide an exact concentration without a site-specific correlation.

In-Situ fluorometers also include a reference detector for Integrated Optical Compensation. This reference detector measures changes in LED brightness and automatically adjusts each reading to compensate for variations caused by temperature or age of the sensor.

Aqua TROLL fluorometers run at unique spectral bands and are filtered with an LED frequency signature to optimize performance. This significantly reduces the effects of ambient lighting conditions and other optical sensors installed in the instrument.

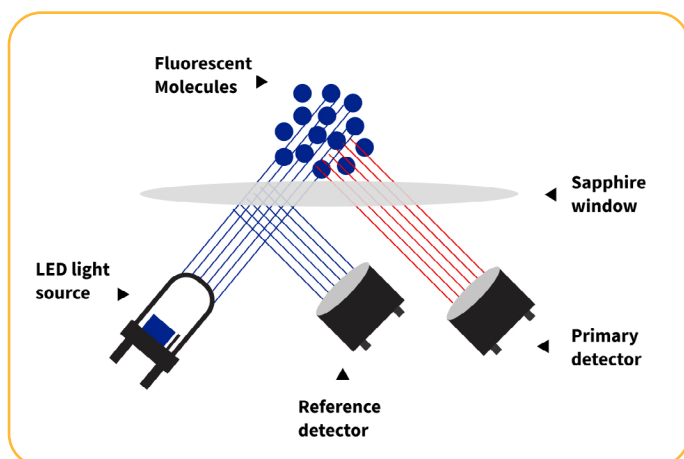

## Potential Interferents

All optical sensors experience interference from turbidity. High turbidity can interrupt a clear path for light to travel to and from the sensor. The same cells that are fluorescing may also increase the turbidity of the water. Thus, the relationship between turbidity and the target parameter is complex. It is not always linear and can be influenced by different particle types.

In all cases, however, turbidity is most likely to lead to an underestimation of the target parameter. Best practice is to always measure turbidity alongside any fluorescence measurement. At the very least, this enables an awareness of possible turbidity interference. In some cases, turbidity measurements can help develop a mathematical correction for turbidity interference. The threshold at which turbidity interference occurs, in either nephelometric turbidity units (NTUs) or formazin nephelometric units (FNU), depends on both the monitoring site and project objectives. Any turbidity corrections must be developed empirically from site-specific measurements.

## Fluorescence Wavelengths

SENSOR	EXCITATION WAVELENGTH (NOMINAL)	DETECTION WAVELENGTH
BGA-PE	498 nm	575 nm to 625 nm

## Derived Parameters: Cell Count and Concentration



To find the scale factor, start by determining the cell count or concentration. Then divide the cell count or concentration by the RFU reading: **Scale factor = Concentration or Cell Count ÷ Fluorescence (in RFU)**

Phycocerythrin (PE) is an accessory pigment produced primarily by red algae, seaweeds, and marine cyanobacteria (also known as blue-green algae). PE containing organisms are generally found at deeper depths and absorb bluer light (thus imparting a red-brown color). An organism containing PE will also have Chlorophyll-a and may contain other accessory pigments. The instrument can derive an estimate for Cell Count (default cells/mL) and Concentration (default µg/L) based on a linear correlation with the Relative Fluorescence of PE measured by the sensor.

The relationship between relative fluorescence and these derived parameters varies highly for each deployment site. The amount of light fluoresced varies by species. Species vary by size, shape, and types of accessory pigments, all of which can affect light output. The cell walls and other cellular structures can alter the path of light into or out of the cell. Phycocerythrin is actively involved in biological processes within cells which can affect how much light is fluoresced. The amount of light fluoresced by any individual organism varies by the age, health, environment and past light history of that individual. Because of these variable characteristics, the correlation of RFU to concentration or cell count needs to be determined empirically for each specific deployment site.

You can enable derived parameters and enter a linear scale factor for your deployment site based on laboratory analysis of grab samples. Once you have determined the cell count or concentration and calculated the scale factor, you can input the scale factor in VuSitu under **Instrument Settings > Derived Parameters**. An example calculation is shown below for reference.

$$\underbrace{54.8 \text{ RFU}}_{\text{FLUORESCENCE}} * \underbrace{1.248}_{\text{SCALE FACTOR}} = \underbrace{68.4 \text{ mg/L}}_{\text{DERIVED CONCENTRATION}}$$

## Additional Information

For additional sensor details including accuracy, range, resolution, methodology, detection limits, response time, and more, see the Aqua TROLL sensor specification sheet at [www.in-situ.com](http://www.in-situ.com).

For more information about this parameter including application information, parameter calculation equations, sensor design, and more, view the parameter page at [www.in-situ.com](http://www.in-situ.com).

## Installation Requirements



Fluorimeters do not require special preparation. Apply a thin layer of grease to the connector O-rings before installing any sensor in the instrument.



Use caution when deploying in direct sunlight or environments with highly-reflective surfaces. Although the sensor's filters reduce the effects of ambient light, very high light levels can interfere with readings.



When using BGA-PC and BGA-PE sensors together in an Aqua TROLL 500 or 600, install in non-adjacent sensor ports. This is not necessary for an Aqua TROLL 700 or 800.

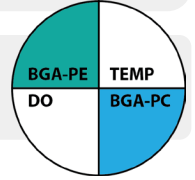

## Chemical Incompatibility



Do not soak the sensor in solvents, such as chlorinated solvents, ethers, or ketones, such as acetone. Do not use metal scraping tools to clean the sensor. Follow the cleaning procedure described below.

## Cleaning



Rinse the sensor face with clean, cold water. If further cleaning is needed, clean the sensor based on the nature of the debris. Begin with the gentlest method and continue to the others only if necessary.

### TO REMOVE SOFT FOULING:



1 Clean the sensor with warm water and mild soap.



2 Soak the sensor in dish soap and warm water.



3 Use a soft brush to gently clean all debris from the optical window.



4 Thoroughly rinse the sensor with deionized water.

### TO REMOVE HARD FOULING:



1 Clean the sensor with warm water and mild soap.



2 Soak the sensor in dilute vinegar.



3 Use a soft brush to gently clean all debris from the optical window.



4 Thoroughly rinse the sensor with deionized water.

## Recommended Calibration Frequency

Calibrating a fluorometer adjusts the relative fluorescence measured by the sensor by applying a slope and offset to the factory-calibrated values. In-Situ's sensors are rigorously calibrated in our factory across their full range and maintain linear fluorescence readings without need for user calibration. To translate fluorescence readings into more meaningful measurements like concentration or cell count, see the above sections for each of these derived parameters.

You can calibrate the sensor to compensate for physical changes to the lens or if you have Standard Operating Procedures that require calibration. Choose **Restore Calibration Defaults** from **Instrument Settings** to return to the last factory calibration.

Calibrate the BGA-PE sensor using one of three methods:

1. **Deionized Water:** Reset the zero point by performing a calibration in deionized water.
2. **Rhodamine Standard:** Calibrate with a Rhodamine WT standard to adjust readings of higher concentrations based on known equivalency. See the instructions on the next page to prepare a Rhodamine WT standard.
3. **Custom Standard or Reference:** Use a reference or a custom calibration standard.

## Calibration Procedure



Fluorometers require more calibration solution than other solution-based calibrations. If solution-based calibration is required, pour solution all the way to the bottom of the restrictor threads.

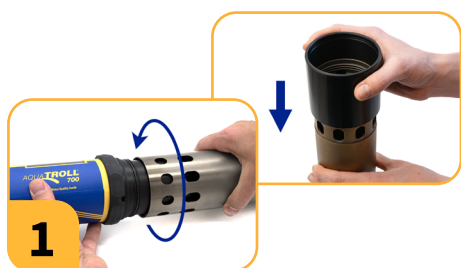

Place the restrictor in calibration mode (holes near the center of the instrument). If you are using a copper restrictor, install the calibration sleeve.

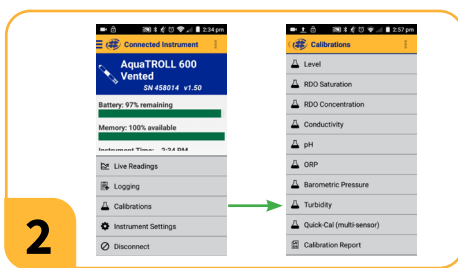

In VuSitu, click Calibrations from the Connected Instrument screen and choose sensor to calibrate.



Remove cap from instrument and pour DI water into restrictor. Use 10-20 mL for Aqua TROLL 500 or 600. Use 20-40 mL for Aqua TROLL 700 or 800.



Gently shake the sonde in a circular motion to rinse the inside of restrictor and sensors, then discard the DI water. Because fluorescence is an optical measurement, rinsing with calibration solution is not necessary.



Pour calibration solution into the restrictor up to the bottom of the threads. Cover the restrictor with the end cap.

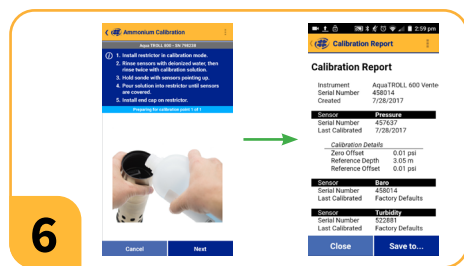

Follow the instructions in VuSitu to start the calibration.

## Preparing Rhodamine WT Calibration Standard



**1** Start with a 2.5% Rhodamine WT solution. Pipette 1.0 mL of the solution into a 250 mL Class A volumetric flask.



**2** Bring the flask to volume with deionized water. The resulting solution is 100 mg/L Rhodamine WT.



**3** To obtain a 200  $\mu\text{g/L}$  concentration, pipette 2.0 mL of the 100 mg/L solution into a 1000 mL flask.



**4** Bring the flask to volume with deionized water.



Use an opaque container to store the 200 mg/L solution in a cool, dark place for up to six months. If desired, use the procedure described above to make a different concentration of Rhodamine WT, such as 400  $\mu\text{g/L}$ . Alter the volume in Step 3 according to the table below to achieve the target concentration. Prepare the dilutions immediately before use and discard after calibration.

TARGET CONCENTRATION	100 MG/L RHODAMINE WT	EXPECTED RFU VALUE AT 25° C
0 $\mu\text{g/L}$ (deionized water)	none	0
100 $\mu\text{g/L}$	1.0 mL	27.0
200 $\mu\text{g/L}$	2.0 mL	54.6
400 $\mu\text{g/L}$	4.0 mL	105

\* These values are for reference only. Actual values may vary based on user-prepared standards.

## Checking Calibration Quality



After calibration, check these indicators in the VuSitu Calibration Report. If you are logged in, Calibration Reports will automatically upload to HydroVu for secure storage and access from any device.

INDICATOR	ACCEPTABLE RANGE	NOTES
Slope	0.7 to 1.3	A sensor at factory defaults will have a slope of 1.

If the values are outside of the ranges listed above, follow these troubleshooting steps. Then try the calibration again.

- Thoroughly clean, rinse, and dry the sensor, restrictor, and calibration equipment.
- Make sure you are using enough calibration solution as described in the calibration procedure in this manual. Always cover the restrictor with the end cap during calibration.
- Check that calibration solutions are not expired.
- From **Instrument Settings**, select **Restore Calibration Defaults**. Then try calibrating again.
- Inspect the lenses for scratches, smudges, or condensation inside the sensor. If you notice major scratches or internal condensation and the sensor is not calibrating properly, you may need to replace your sensor.
- Make sure the sensor has been stored properly according to the instructions in this manual.
- Check whether the sensor is reaching the end of its expected life. It may be time to replace your sensor.

## Shelf Life for In-Situ Solutions

SOLUTION	SHELF LIFE - UNOPENED	SHELF LIFE - OPENED
Deionized Water	24 months	Hours, check before use for calibration

## Maintenance



Fluorometers do not have unique maintenance requirements aside from cleaning as described in this manual. Change the connector O-rings as part of routine instrument maintenance.

## Storage



Fluorometers do not have any unique storage requirements. They can be stored wet or dry. Cover the connector with the included dust cover when it is not in use to protect the connector from corrosion or fouling.

## Expected Sensor Life

Follow all recommendations in this manual to maximize the life of your sensor. Fluorometers can last years depending on site and storage conditions. The lifetime may be reduced if the instrument is installed in abrasive or corrosive conditions, cleaned improperly, or deployed outside of its operational temperature and pressure ranges.

# FDOM Sensor

## About the Sensor

This sensor uses fluorescence to measure Fluorescent Dissolved Organic Matter (FDOM). The sensor includes integrated optical compensation to compensate for LED drift over temperature and time and isolated optical frequencies to minimize interference and improve accuracy.



## How It Works

FDOM sensors are fluorometers. Many molecules can absorb light from a specific spectrum and then emit light at a different wavelength in a process known as fluorescence. Fluorometers are optical instruments that measure the fluorescence of substances in water.

These fluorescent molecules are detected using a carefully designed system. An LED emitter generates light at a specific wavelength, and filters isolate the desired excitation spectrum. When this light reaches fluorescent molecules in a water sample, they absorb the energy and emit light at a longer wavelength (lower energy). This emitted light is known as the fluorescence signature.

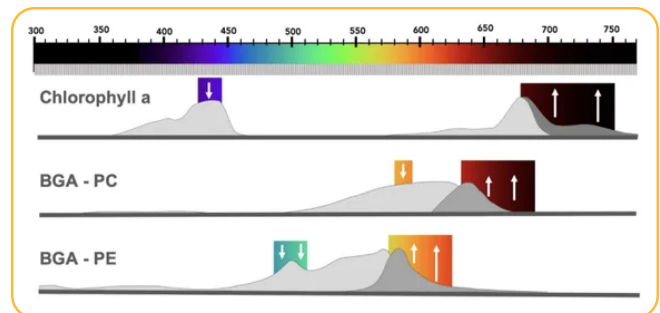

The sensor's detector, equipped with its own set of filters, captures the emitted light and measures its intensity. Because fluorescence intensity is proportional to the concentration of fluorescent molecules, the sensor can estimate the concentration of target substances in the water. As concentration increases, more molecules absorb the excitation light, typically resulting in stronger fluorescence.

Measurements are typically expressed in Relative Fluorescence Units (RFUs). RFUs indicate relative changes in concentration of the fluorescent substance, but they do not provide an exact concentration without a site-specific correlation.

In-Situ fluorometers also include a reference detector for Integrated Optical Compensation. This reference detector measures changes in LED brightness and automatically adjusts each reading to compensate for variations caused by temperature or age of the sensor.

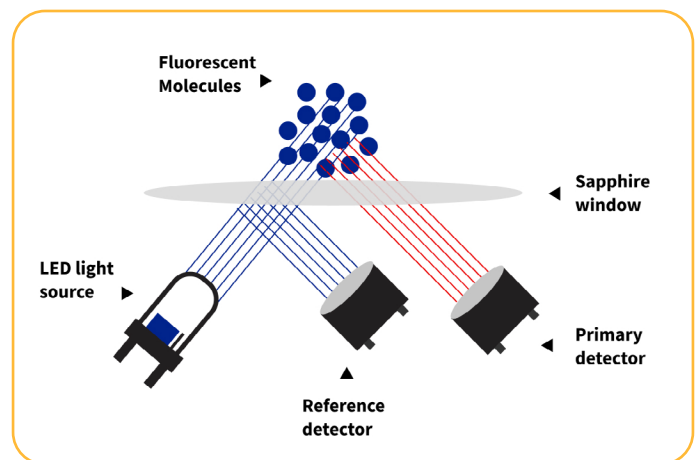

Aqua TROLL fluorometers run at unique spectral bands and are filtered with an LED frequency signature to optimize performance. This significantly reduces the effects of ambient lighting conditions and other optical sensors installed in the instrument.

## Potential Interferents

All optical sensors experience interference from turbidity. High turbidity can interrupt a clear path for light to travel to and from the sensor. Additionally, suspended particles provide surfaces where fluorescent molecules can adsorb. This removes fluorescent compounds from the dissolved fraction and can change the fluorescent characteristics of the target molecules. Thus, the relationship between turbidity and the target parameter is complex. It is not always linear and can be influenced by different particle types.

In all cases, however, turbidity is most likely to lead to an underestimation of the target parameter. Best practice is to always measure turbidity alongside any fluorescence measurement. At the very least, this enables an awareness of possible turbidity interference. In some cases, turbidity measurements can help develop a mathematical correction for turbidity interference. The threshold at which turbidity interference occurs, in either nephelometric turbidity units (NTUs) or formazin nephelometric units (FNU), depends on both the monitoring site and project objectives. Any turbidity corrections must be developed empirically from site-specific measurements.

## Fluorescence Wavelengths

SENSOR	EXCITATION WAVELENGTH (NOMINAL)	DETECTION WAVELENGTH
FDOM	375 nm	455 nm to 530 nm

## Derived Parameters: FDOM and CDOM Concentration



To find the scale factor, start by determining the cell count or concentration. Then divide the cell count or concentration by the RFU reading: **Scale factor = Concentration ÷ Fluorescence (in RFU)**

Fluorescent dissolved organic matter (FDOM) is a key parameter in water quality monitoring that helps us understand the presence, types and turnover of organic materials in water. FDOM is a subset of dissolved organic molecules that will fluoresce under UV light. Often FDOM scales with CDOM (Colored Dissolved Organic Matter) and is used as a proxy measurement for CDOM. The instrument can derive an estimate for FDOM Concentration (default µg/L) and CDOM Concentration (default µg/L) based on a linear correlation with the Relative Fluorescence measured by the sensor.

The relationship between relative fluorescence and these derived parameters varies highly for each deployment site. FDOM from natural sources tends to be the decay products from dead and degrading plants and bacteria. As such, there might be hundreds or thousands of slightly differing molecules being assayed, each with unique characteristics that affect how much fluorescence is emitted. Excitation light from the LED or emitted fluorescence might also be absorbed by other molecules in the water which can lead to a non-linear response. Because of these variable characteristics, the correlation of RFU to FDOM or CDOM concentration needs to be determined empirically for each specific deployment site.

You can enable derived parameters and enter a linear scale factor for your deployment site based on laboratory analysis of grab samples. Once you have determined the cell count or concentration and calculated the scale factor, you can input the scale factor in VuSitu under **Instrument Settings > Derived Parameters**. An example calculation is shown below for reference.

$$\underbrace{54.8 \text{ RFU}}_{\text{FLUORESCENCE}} * \underbrace{1.248}_{\text{SCALE FACTOR}} = \underbrace{68.4 \text{ } \mu\text{g/L}}_{\text{DERIVED CONCENTRATION}}$$

## Additional Information

For additional sensor details including accuracy, range, resolution, methodology, detection limits, response time, and more, see the Aqua TROLL sensor specification sheet at [www.in-situ.com](http://www.in-situ.com).

For more information about this parameter including application information, parameter calculation equations, sensor design, and more, view the parameter page at [www.in-situ.com](http://www.in-situ.com).

## Installation Requirements



Do not look directly at the sensor LED or point it at the eyes. Doing so can cause eye damage from UV light emitted by the LED.



Fluorometers do not require special preparation. Apply a thin layer of grease to the connector O-rings before installing any sensor in the instrument.



Use caution when deploying in direct sunlight or environments with highly-reflective surfaces. Although the sensor's filters reduce the effects of ambient light, very high light levels can interfere with readings.

## Chemical Incompatibility



Do not soak the sensor in solvents, such as chlorinated solvents, ethers, or ketones, such as acetone. Do not use metal scraping tools to clean the sensor. Follow the cleaning procedure described below.

## Cleaning



Rinse the sensor face with clean, cold water. If further cleaning is needed, clean the sensor based on the nature of the debris. Begin with the gentlest method and continue to the others only if necessary.

### TO REMOVE SOFT FOULING:



**1** Clean the sensor with warm water and mild soap.



**2** Soak the sensor in dish soap and warm water.



**3** Use a soft brush to gently clean all debris from the optical window.



**4** Thoroughly rinse the sensor with deionized water.

### TO REMOVE HARD FOULING:



**1** Clean the sensor with warm water and mild soap.



**2** Soak the sensor in dilute vinegar.



**3** Use a soft brush to gently clean all debris from the optical window.



**4** Thoroughly rinse the sensor with deionized water.

## Recommended Calibration Frequency

Calibrating a fluorometer adjusts the relative fluorescence measured by the sensor by applying a slope and offset to the factory-calibrated values. In-Situ's sensors are rigorously calibrated in our factory across their full range and maintain linear fluorescence readings without need for user calibration.

You can calibrate the sensor to compensate for physical changes to the lens or if you have Standard Operating Procedures that require calibration. Choose **Restore Calibration Defaults** from **Instrument Settings** to return to the last factory calibration.

Calibrate the FDOM sensor using one of two methods:

1. **Deionized Water:** Reset the zero point by performing a calibration in deionized water.
2. **Solid State Calibrator:** Use the FDOM Solid State RFU Calibrator as a stable and repeatable solid-state standard to perform RFU calibrations and checks on the Aqua TROLL FDOM sensor. Calibrate the sensor to the standard value and use the same standard to check your sensor to ensure the sensor response has not changed over time.

## Calibration Procedure



If possible, use the solid state calibrator provided by In-Situ rather than a liquid standard. If solution-based calibration is required, pour solution all the way to the bottom of the restrictor threads. Fluorometers require more calibration solution than other solution-based calibrations.



You can batch calibrate a group of sensors at the same time to reduce time and calibration solution.

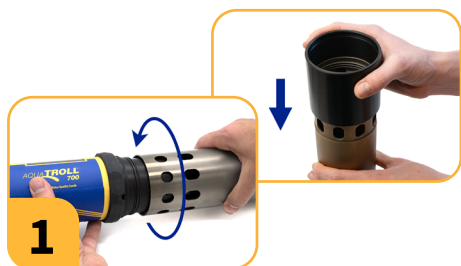

Place the restrictor in calibration mode (holes near the center of the instrument). If you are using a copper restrictor, install the calibration sleeve.

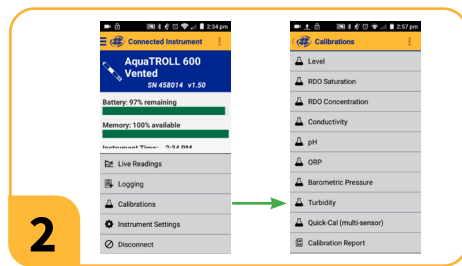

In VuSitu, click Calibrations from the Connected Instrument screen and choose sensor to calibrate.



Remove cap from instrument and pour DI water into restrictor. Use 10-20 mL for Aqua TROLL 500 or 600. Use 20-40 mL for Aqua TROLL 700 or 800.



Gently shake the sonde in a circular motion to rinse the inside of restrictor and sensors, then discard the DI water. Because fluorescence is an optical measurement, rinsing with calibration solution is not necessary.



Place the calibrator in the end of the restrictor. Take note of the standard value from the top of the calibrator.



Follow the instructions in VuSitu to start the calibration. Enter the standard value from the top of the calibrator when prompted in VuSitu.

## Checking Calibration Quality



After calibration, check these indicators in the VuSitu Calibration Report. If you are logged in, Calibration Reports will automatically upload to HydroVu for secure storage and access from any device.

INDICATOR	ACCEPTABLE RANGE	NOTES
Slope	0.7 to 1.3	A sensor at factory defaults will have a slope of 1.

If the values are outside of the ranges listed above, follow these troubleshooting steps. Then try the calibration again.

- Thoroughly clean, rinse, and dry the sensor, restrictor, and calibration equipment.
- Check that calibration solutions are not expired.
- From **Instrument Settings**, select **Restore Calibration Defaults**. Then try calibrating again.
- Inspect the lenses for scratches, smudges, or condensation inside the sensor. If you notice major scratches or internal condensation and the sensor is not calibrating properly, you may need to replace your sensor.
- Make sure the sensor has been stored properly according to the instructions in this manual.
- Check whether the sensor is reaching the end of its expected life. It may be time to replace your sensor.

## Shelf Life for In-Situ Solutions

SOLUTION	SHELF LIFE - UNOPENED	SHELF LIFE - OPENED
Deionized Water	24 months	Hours, check before use for calibration

## Maintenance



Fluorometers do not have unique maintenance requirements aside from cleaning as described in this manual. Change the connector O-rings as part of routine instrument maintenance.

## Storage



Fluorometers do not have any unique storage requirements. They can be stored wet or dry. Cover the connector with the included dust cover when it is not in use to protect the connector from corrosion or fouling.

## Expected Sensor Life

Follow all recommendations in this manual to maximize the life of your sensor. Fluorometers can last years depending on site and storage conditions. The lifetime may be reduced if the instrument is installed in abrasive or corrosive conditions, cleaned improperly, or deployed outside of its operational temperature and pressure ranges.

# Crude Oil Sensor

## About the Sensor

This sensor uses fluorescence to measure low concentrations of Crude Oil in water. The sensor includes integrated optical compensation to compensate for LED drift over temperature and time and isolated optical frequencies to minimize interference and improve accuracy.



## How It Works

Crude Oil sensors are fluorometers. Many molecules can absorb light from a specific spectrum and then emit light at a different wavelength in a process known as fluorescence. Fluorometers are optical instruments that measure the fluorescence of substances in water.

These fluorescent molecules are detected using a carefully designed system. An LED emitter generates light at a specific wavelength, and filters isolate the desired excitation spectrum. When this light reaches fluorescent molecules in a water sample, they absorb the energy and emit light at a longer wavelength (lower energy). This emitted light is known as the fluorescence signature.

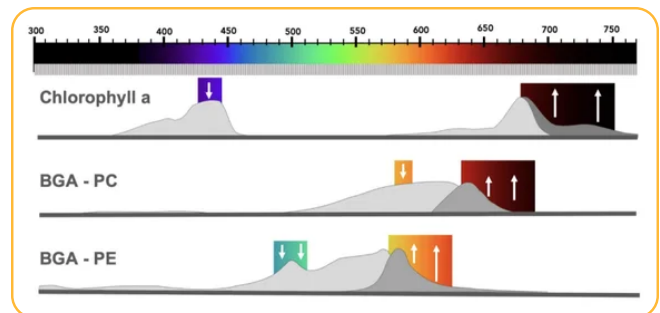

The sensor's detector, equipped with its own set of filters, captures the emitted light and measures its intensity. Because fluorescence intensity is proportional to the concentration of fluorescent molecules, the sensor can estimate the concentration of target substances in the water. As concentration increases, more molecules absorb the excitation light, typically resulting in stronger fluorescence.

Measurements are typically expressed in Relative Fluorescence Units (RFUs). RFUs indicate relative changes in concentration of the fluorescent substance, but they do not provide an exact concentration without a site-specific correlation.

In-Situ fluorometers also include a reference detector for Integrated Optical Compensation. This reference detector measures changes in LED brightness and automatically adjusts each reading to compensate for variations caused by temperature or age of the sensor.

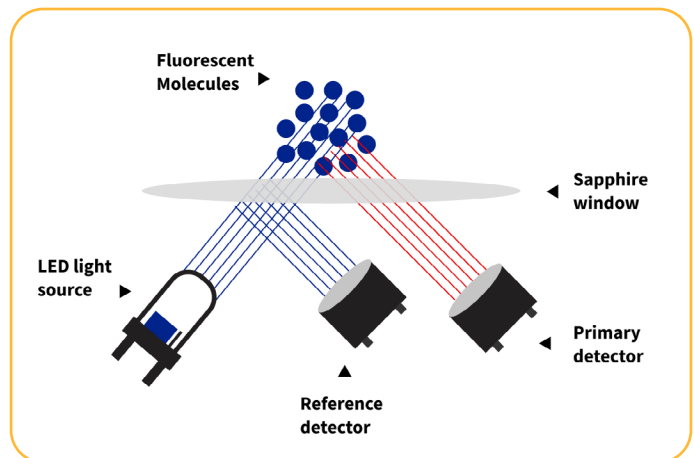

Aqua TROLL fluorometers run at unique spectral bands and are filtered with an LED frequency signature to optimize performance. This significantly reduces the effects of ambient lighting conditions and other optical sensors installed in the instrument.

## Potential Interferents

All optical sensors experience interference from turbidity. High turbidity can interrupt a clear path for light to travel to and from the sensor. Additionally, suspended particles provide surfaces where fluorescent molecules can adsorb. This removes fluorescent compounds from the dissolved fraction and can change the fluorescent characteristics of the target molecules. Thus, the relationship between turbidity and the target parameter is complex. It is not always linear and can be influenced by different particle types.

In all cases, however, turbidity is most likely to lead to an underestimation of the target parameter. Best practice is to always measure turbidity alongside any fluorescence measurement. At the very least, this enables an awareness of possible turbidity interference. In some cases, turbidity measurements can help develop a mathematical correction for turbidity interference. The threshold at which turbidity interference occurs, in either nephelometric turbidity units (NTUs) or formazin nephelometric units (FNU), depends on both the monitoring site and project objectives. Any turbidity corrections must be developed empirically from site-specific measurements.

## Fluorescence Wavelengths

SENSOR	EXCITATION WAVELENGTH (NOMINAL)	DETECTION WAVELENGTH
Crude Oil	365 nm	430 nm to 505 nm

## Derived Parameters: Crude Oil Concentration



To find the scale factor, start by determining the cell count or concentration. Then divide the cell count or concentration by the RFU reading: **Scale factor = Concentration ÷ Fluorescence (in RFU)**

Crude oil is unprocessed or unrefined oil which is extracted from the earth. At low concentrations, very small amounts of crude oil can dissolve in water before saturation occurs. The Crude Oil sensor is designed to detect that dissolved portion of crude oil in water. Crude oil dissolved in water can be a useful parameter to indicate minor leaks from crude oil production or storage facilities, presence or absence of crude oil in natural waters, and information on control and containment of oil spills. The instrument can derive an estimate for Crude Oil Concentration (default µg/L) based on a linear correlation with the Relative Fluorescence measured by the sensor.

The Crude Oil sensor responds to fluorescence from several thousand related molecules that fluoresce due to their ring systems. The partitioning of these molecules from the oil phase into the aqueous phase is dependent on the initial volumes of the two phases, the source of the crude oil, temperature, surface area, contact time, etc. Excitation light from the LED or emitted fluorescence might also be absorbed by other molecules in the water which can lead to a non-linear response. Because of these variable characteristics, the correlation of RFU to Crude Oil concentration needs to be determined empirically for each specific deployment site.

You can enable derived parameters and enter a linear scale factor for your deployment site based on laboratory analysis of grab samples. Once you have determined the cell count or concentration and calculated the scale factor, you can input the scale factor in VuSitu under **Instrument Settings > Derived Parameters**. An example calculation is shown below for reference.

$$\underbrace{54.8 \text{ RFU}}_{\text{FLUORESCENCE}} * \underbrace{1.248}_{\text{SCALE FACTOR}} = \underbrace{68.4 \text{ } \mu\text{g/L}}_{\text{DERIVED CONCENTRATION}}$$

## Additional Information

For additional sensor details including accuracy, range, resolution, methodology, detection limits, response time, and more, see the Aqua TROLL sensor specification sheet at [www.in-situ.com](http://www.in-situ.com).

For more information about this parameter including application information, parameter calculation equations, sensor design, and more, view the parameter page at [www.in-situ.com](http://www.in-situ.com).

## Installation Requirements



Do not look directly at the sensor LED or point it at the eyes. Doing so can cause eye damage from UV light emitted by the LED.



Fluorometers do not require special preparation. Apply a thin layer of grease to the connector O-rings before installing any sensor in the instrument.



Use caution when deploying in direct sunlight or environments with highly-reflective surfaces. Although the sensor's filters reduce the effects of ambient light, very high light levels can interfere with readings.

## Chemical Incompatibility



Do not soak the sensor in solvents, such as chlorinated solvents, ethers, or ketones, such as acetone. Do not use metal scraping tools to clean the sensor. Follow the cleaning procedure described below.



Do not immerse the sensor in crude oil. The sensor is designed to pick up low concentrations of crude oil dissolved in water. Immersing the sensor in crude oil can damage or destroy the sensor.

## Cleaning



Rinse the sensor face with clean, cold water. If further cleaning is needed, clean the sensor based on the nature of the debris. Begin with the gentlest method and continue to the others only if necessary.

### TO REMOVE SOFT FOULING:



**1** Clean the sensor with warm water and mild soap.



**2** Soak the sensor in dish soap and warm water.



**3** Use a soft brush to gently clean all debris from the optical window.



**4** Thoroughly rinse the sensor with deionized water.

### TO REMOVE HARD FOULING:



**1** Clean the sensor with warm water and mild soap.



**2** Soak the sensor in dilute vinegar.



**3** Use a soft brush to gently clean all debris from the optical window.



**4** Thoroughly rinse the sensor with deionized water.



## Recommended Calibration Frequency

Calibrating a fluorometer adjusts the relative fluorescence measured by the sensor by applying a slope and offset to the factory-calibrated values. In-Situ's sensors are rigorously calibrated in our factory across their full range and maintain linear fluorescence readings without need for user calibration.

You can calibrate the sensor to compensate for physical changes to the lens or if you have Standard Operating Procedures that require calibration. Choose **Restore Calibration Defaults** from **Instrument Settings** to return to the last factory calibration.

Calibrate the Crude Oil sensor using one of two methods:

- 1. Deionized Water:** Reset the zero point by performing a calibration in deionized water.
- 2. Solid State Calibrator:** Use the Crude Oil Solid State RFU Calibrator as a stable and repeatable solid-state standard to perform RFU calibrations and checks on the Aqua TROLL Crude Oil sensor. Calibrate the sensor to the standard value and use the same standard to check your sensor to ensure the sensor response has not changed over time.

## Calibration Procedure



If possible, use the solid state calibrator provided by In-Situ rather than a liquid standard. If solution-based calibration is required, pour solution all the way to the bottom of the restrictor threads. Fluorometers require more calibration solution than other solution-based calibrations.



You can batch calibrate a group of sensors at the same time to reduce time and calibration solution.

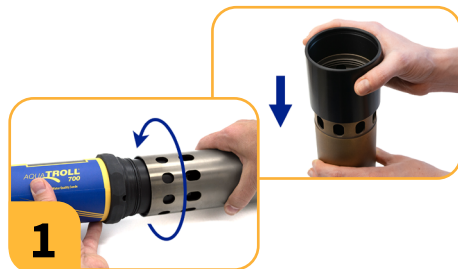

Place the restrictor in calibration mode (holes near the center of the instrument). If you are using a copper restrictor, install the calibration sleeve.

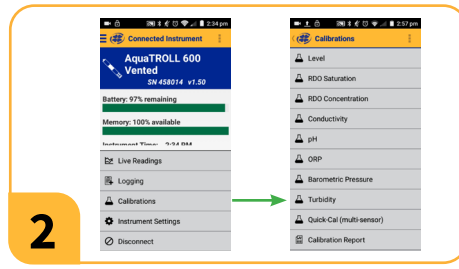

In VuSitu, click Calibrations from the Connected Instrument screen and choose sensor to calibrate.



Remove cap from instrument and pour DI water into restrictor. Use 10-20 mL for Aqua TROLL 500 or 600. Use 20-40 mL for Aqua TROLL 700 or 800.



Gently shake the sonde in a circular motion to rinse the inside of restrictor and sensors, then discard the DI water. Because fluorescence is an optical measurement, rinsing with calibration solution is not necessary.



Place the calibrator in the end of the restrictor. Take note of the standard value from the top of the calibrator.



Follow the instructions in VuSitu to start the calibration. Enter the standard value from the top of the calibrator when prompted in VuSitu.

## Checking Calibration Quality



After calibration, check these indicators in the VuSitu Calibration Report. If you are logged in, Calibration Reports will automatically upload to HydroVu for secure storage and access from any device.

INDICATOR	ACCEPTABLE RANGE	NOTES
Slope	0.7 to 1.3	A sensor at factory defaults will have a slope of 1.

If the values are outside of the ranges listed above, follow these troubleshooting steps. Then try the calibration again.

- Thoroughly clean, rinse, and dry the sensor, restrictor, and calibration equipment.
- Check that calibration solutions are not expired.
- From **Instrument Settings**, select **Restore Calibration Defaults**. Then try calibrating again.
- Inspect the lenses for scratches, smudges, or condensation inside the sensor. If you notice major scratches or internal condensation and the sensor is not calibrating properly, you may need to replace your sensor.
- Make sure the sensor has been stored properly according to the instructions in this manual.
- Check whether the sensor is reaching the end of its expected life. It may be time to replace your sensor.

## Shelf Life for In-Situ Solutions

SOLUTION	SHELF LIFE - UNOPENED	SHELF LIFE - OPENED
Deionized Water	24 months	Hours, check before use for calibration

## Maintenance



Fluorometers do not have unique maintenance requirements aside from cleaning as described in this manual. Change the connector O-rings as part of routine instrument maintenance.

## Storage



Fluorometers do not have any unique storage requirements. They can be stored wet or dry. Cover the connector with the included dust cover when it is not in use to protect the connector from corrosion or fouling.

## Expected Sensor Life

Follow all recommendations in this manual to maximize the life of your sensor. Fluorometers can last years depending on site and storage conditions. The lifetime may be reduced if the instrument is installed in abrasive or corrosive conditions, cleaned improperly, or deployed outside of its operational temperature and pressure ranges.

# Rhodamine WT Sensor

## About the Sensor

This sensor uses fluorescence to measure Rhodamine Water Tracer. The sensor includes integrated optical compensation to compensate for LED drift over temperature and time and isolated optical frequencies to minimize interference and improve accuracy.



## How It Works

Rhodamine WT sensors are fluorometers. Many molecules can absorb light from a specific spectrum and then emit light at a different wavelength in a process known as fluorescence. Fluorometers are optical instruments that measure the fluorescence of substances in water.

These fluorescent molecules are detected using a carefully designed system. An LED emitter generates light at a specific wavelength, and filters isolate the desired excitation spectrum. When this light reaches fluorescent molecules in a water sample, they absorb the energy and emit light at a longer wavelength (lower energy). This emitted light is known as the fluorescence signature.

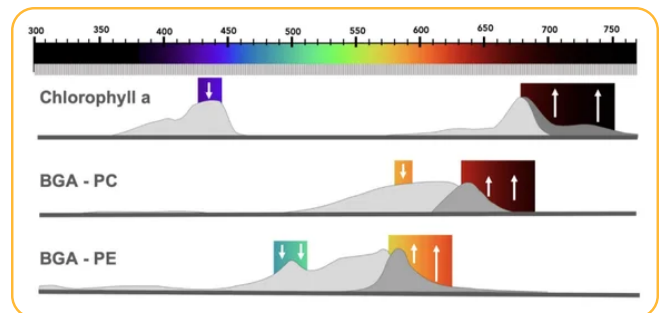

The sensor's detector, equipped with its own set of filters, captures the emitted light and measures its intensity. Because fluorescence intensity is proportional to the concentration of fluorescent molecules, the sensor can estimate the concentration of target substances in the water. As concentration increases, more molecules absorb the excitation light, typically resulting in stronger fluorescence.

Measurements are typically expressed in Relative Fluorescence Units (RFUs). RFUs indicate relative changes in concentration of the fluorescent substance and are used to calculate the concentration of Rhodamine in the water.

In-Situ fluorometers also include a reference detector for Integrated Optical Compensation. This reference detector measures changes in LED brightness and automatically adjusts each reading to compensate for variations caused by temperature or age of the sensor.

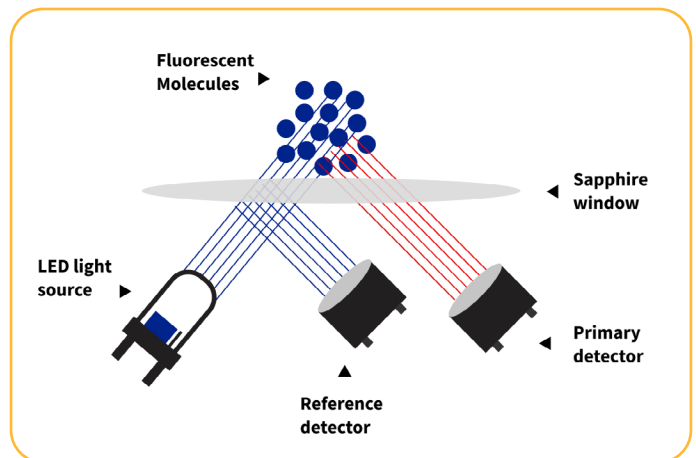

Aqua TROLL fluorometers run at unique spectral bands and are filtered with an LED frequency signature to optimize performance. This significantly reduces the effects of ambient lighting conditions and other optical sensors installed in the instrument.

## Potential Interferents

All optical sensors experience interference from turbidity. High turbidity can interrupt a clear path for light to travel to and from the sensor. Additionally, suspended particles provide surfaces where fluorescent molecules can adsorb. This removes fluorescent compounds from the dissolved fraction and can change the fluorescent characteristics of the target molecules. Thus, the relationship between turbidity and the target parameter is complex. It is not always linear and can be influenced by different particle types.

In all cases, however, turbidity is most likely to lead to an underestimation of the target parameter. Best practice is to always measure turbidity alongside any fluorescence measurement. At the very least, this enables an awareness of possible turbidity interference. In some cases, turbidity measurements can help develop a mathematical correction for turbidity interference. The threshold at which turbidity interference occurs, in either nephelometric turbidity units (NTUs) or formazin nephelometric units (FNU), depends on both the monitoring site and project objectives. Any turbidity corrections must be developed empirically from site-specific measurements.

## Fluorescence Wavelengths

SENSOR	EXCITATION WAVELENGTH (NOMINAL)	DETECTION WAVELENGTH
Rhodamine WT	530 nm	580 nm to 660 nm

## Rhodamine WT Concentration



Rhodamine WT Concentration is available to read by default and does not require an empirical scale factor like other fluorometer readings.

Rhodamine WT is a fluorescent dye commonly used as a tracer in water tracing studies within hydrology. Rhodamines are a class of related molecules that mostly fluoresce in the same bands. Due to toxicity and lingering environmental presence of the compounds, a specialized version of Rhodamine (WT) was developed for water tracing purposes. It has the advantages of being highly fluorescent and breaks down quickly in the environment.

Many other fluorometers require an empirical correlation to derive meaningful parameters for a specific deployment site. Because Rhodamine WT is a standardized compound that is not subject to biological variations, concentration can be calculated directly from fluorescence without the need for a site-specific scale factor. Every 1 RFU increase represents an increase of 10 ug/L of Rhodamine WT. Rhodamine concentration is calculated using methods from:

P.L. Smart, I.M.S. Laidlaw, An evaluation of some fluorescent dyes for water tracing. Water Resources Research, Vol. 13, No. 1 Feb. 1977

## Additional Information

For additional sensor details including accuracy, range, resolution, methodology, detection limits, response time, and more, see the Aqua TROLL sensor specification sheet at [www.in-situ.com](http://www.in-situ.com).

For more information about this parameter including application information, parameter calculation equations, sensor design, and more, view the parameter page at [www.in-situ.com](http://www.in-situ.com).

## Installation Requirements



The calculation of rhodamine concentration depends on temperature. For the fastest response time, use the Rhodamine sensor with a dedicated Temperature or Temperature/Conductivity sensor.



Fluorometers do not require special preparation. Apply a thin layer of grease to the connector O-rings before installing any sensor in the instrument.



Use caution when deploying in direct sunlight or environments with highly-reflective surfaces. Although the sensor's filters reduce the effects of ambient light, very high light levels can interfere with readings.

## Chemical Incompatibility



Do not soak the sensor in solvents, such as chlorinated solvents, ethers, or ketones, such as acetone. Do not use metal scraping tools to clean the sensor. Follow the cleaning procedure described below.

## Cleaning



Rinse the sensor face with clean, cold water. If further cleaning is needed, clean the sensor based on the nature of the debris. Begin with the gentlest method and continue to the others only if necessary.

### TO REMOVE SOFT FOULING:



**1** Clean the sensor with warm water and mild soap.



**2** Soak the sensor in dish soap and warm water.



**3** Use a soft brush to gently clean all debris from the optical window.



**4** Thoroughly rinse the sensor with deionized water.

### TO REMOVE HARD FOULING:



**1** Clean the sensor with warm water and mild soap.



**2** Soak the sensor in dilute vinegar.



**3** Use a soft brush to gently clean all debris from the optical window.



**4** Thoroughly rinse the sensor with deionized water.

# Recommended Calibration Frequency

Calibrating a fluorometer adjusts the relative fluorescence measured by the sensor by applying a slope and offset to the factory-calibrated values. In-Situ's sensors are rigorously calibrated in our factory across their full range and maintain linear fluorescence readings without need for user calibration.

You can calibrate the sensor to compensate for physical changes to the lens or if you have Standard Operating Procedures that require calibration. Choose **Restore Calibration Defaults** from **Instrument Settings** to return to the last factory calibration.

Calibrate the Rhodamine WT sensor using one of two methods:

- 1. Deionized Water:** Reset the zero point by performing a calibration in deionized water.
- 2. Rhodamine Standard:** Calibrate with a Rhodamine WT standard to adjust readings of higher concentrations based on known equivalency. See the instructions on the next page to prepare a Rhodamine WT standard.

# Calibration Procedure



Fluorometers require more calibration solution than other solution-based calibrations. If solution-based calibration is required, pour solution all the way to the bottom of the restrictor threads.



You can batch calibrate a group of sensors at the same time to reduce time and calibration solution.

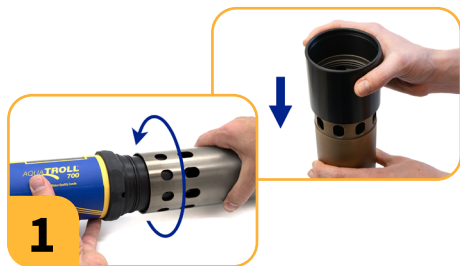

Place the restrictor in calibration mode (holes near the center of the instrument). If you are using a copper restrictor, install the calibration sleeve.

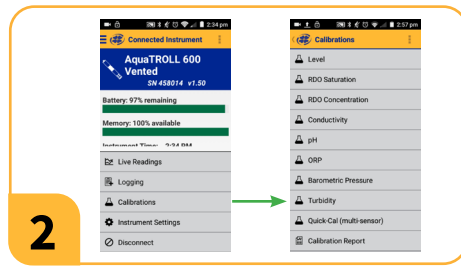

In VuSitu, click Calibrations from the Connected Instrument screen and choose sensor to calibrate.



Remove cap from instrument and pour DI water into restrictor. Use 10-20 mL for Aqua TROLL 500 or 600. Use 20-40 mL for Aqua TROLL 700 or 800.



Gently shake the sonde in a circular motion to rinse the inside of restrictor and sensors, then discard the DI water. Because fluorescence is an optical measurement, rinsing with calibration solution is not necessary.



Pour calibration solution into the restrictor up to the bottom of the threads. Cover the restrictor with the end cap.



Follow the instructions in VuSitu to start the calibration.

## Preparing Rhodamine WT Calibration Standard



**1** Start with a 2.5% Rhodamine WT solution. Pipette 1.0 mL of the solution into a 250 mL Class A volumetric flask.



**2** Bring the flask to volume with deionized water. The resulting solution is 100 mg/L Rhodamine WT.



**3** To obtain a 200  $\mu\text{g/L}$  concentration, pipette 2.0 mL of the 100 mg/L solution into a 1000 mL flask.



**4** Bring the flask to volume with deionized water.



Use an opaque container to store the 200 mg/L solution in a cool, dark place for up to six months. If desired, use the procedure described above to make a different concentration of Rhodamine WT, such as 400  $\mu\text{g/L}$ . Alter the volume in Step 3 according to the table below to achieve the target concentration. Prepare the dilutions immediately before use and discard after calibration.

TARGET CONCENTRATION	100 MG/L RHODAMINE WT	EXPECTED RFU VALUE AT 25° C
0 $\mu\text{g/L}$ (deionized water)	none	0
100 $\mu\text{g/L}$	1.0 mL	10
200 $\mu\text{g/L}$	2.0 mL	20
400 $\mu\text{g/L}$	4.0 mL	40

\* These values are for reference only. Actual values may vary based on user-prepared standards.

## Checking Calibration Quality



After calibration, check these indicators in the VuSitu Calibration Report. If you are logged in, Calibration Reports will automatically upload to HydroVu for secure storage and access from any device.

INDICATOR	ACCEPTABLE RANGE	NOTES
Slope	0.7 to 1.3	A sensor at factory defaults will have a slope of 1.

If the values are outside of the ranges listed above, follow these troubleshooting steps. Then try the calibration again.

- Thoroughly clean, rinse, and dry the sensor, restrictor, and calibration equipment.
- Make sure you are using enough calibration solution as described in the calibration procedure in this manual. Always cover the restrictor with the end cap during calibration.
- Check that calibration solutions are not expired.
- From **Instrument Settings**, select **Restore Calibration Defaults**. Then try calibrating again.
- Inspect the lenses for scratches, smudges, or condensation inside the sensor. If you notice major scratches or internal condensation and the sensor is not calibrating properly, you may need to replace your sensor.
- Make sure the sensor has been stored properly according to the instructions in this manual.
- Check whether the sensor is reaching the end of its expected life. It may be time to replace your sensor.

## Shelf Life for In-Situ Solutions

SOLUTION	SHELF LIFE - UNOPENED	SHELF LIFE - OPENED
Deionized Water	24 months	Hours, check before use for calibration

## Maintenance



Fluorometers do not have unique maintenance requirements aside from cleaning as described in this manual. Change the connector O-rings as part of routine instrument maintenance.

## Storage



Fluorometers do not have any unique storage requirements. They can be stored wet or dry. Cover the connector with the included dust cover when it is not in use to protect the connector from corrosion or fouling.

## Expected Sensor Life

Follow all recommendations in this manual to maximize the life of your sensor. Fluorometers can last years depending on site and storage conditions. The lifetime may be reduced if the instrument is installed in abrasive or corrosive conditions, cleaned improperly, or deployed outside of its operational temperature and pressure ranges.

# Fluorescein WT Sensor

## About the Sensor

This sensor uses fluorescence to measure Fluorescein Water Tracer. The sensor includes integrated optical compensation to compensate for LED drift over temperature and time and isolated optical frequencies to minimize interference and improve accuracy.



## How It Works

Fluorescein WT sensors are fluorometers. Many molecules can absorb light from a specific spectrum and then emit light at a different wavelength in a process known as fluorescence. Fluorometers are optical instruments that measure the fluorescence of substances in water.

These fluorescent molecules are detected using a carefully designed system. An LED emitter generates light at a specific wavelength, and filters isolate the desired excitation spectrum. When this light reaches fluorescent molecules in a water sample, they absorb the energy and emit light at a longer wavelength (lower energy). This emitted light is known as the fluorescence signature.

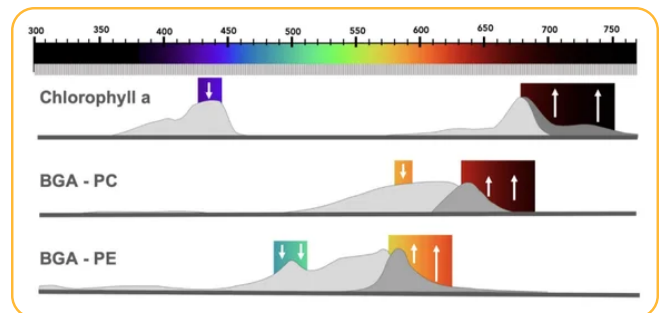

The sensor's detector, equipped with its own set of filters, captures the emitted light and measures its intensity. Because fluorescence intensity is proportional to the concentration of fluorescent molecules, the sensor can estimate the concentration of target substances in the water. As concentration increases, more molecules absorb the excitation light, typically resulting in stronger fluorescence.

Measurements are typically expressed in Relative Fluorescence Units (RFUs). RFUs indicate relative changes in concentration of the fluorescent substance and are used to calculate the concentration of Fluorescein in the water.

In-Situ fluorometers also include a reference detector for Integrated Optical Compensation. This reference detector measures changes in LED brightness and automatically adjusts each reading to compensate for variations caused by temperature or age of the sensor.

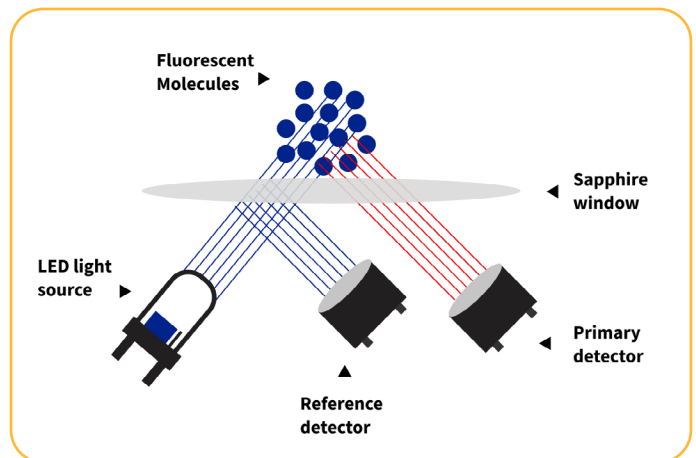

Aqua TROLL fluorometers run at unique spectral bands and are filtered with an LED frequency signature to optimize performance. This significantly reduces the effects of ambient lighting conditions and other optical sensors installed in the instrument.

## Potential Interferents

All optical sensors experience interference from turbidity. High turbidity can interrupt a clear path for light to travel to and from the sensor. Additionally, suspended particles provide surfaces where fluorescent molecules can adsorb. This removes fluorescent compounds from the dissolved fraction and can change the fluorescent characteristics of the target molecules. Thus, the relationship between turbidity and the target parameter is complex. It is not always linear and can be influenced by different particle types.

In all cases, however, turbidity is most likely to lead to an underestimation of the target parameter. Best practice is to always measure turbidity alongside any fluorescence measurement. At the very least, this enables an awareness of possible turbidity interference. In some cases, turbidity measurements can help develop a mathematical correction for turbidity interference. The threshold at which turbidity interference occurs, in either nephelometric turbidity units (NTUs) or formazin nephelometric units (FNU), depends on both the monitoring site and project objectives. Any turbidity corrections must be developed empirically from site-specific measurements.

## Fluorescence Wavelengths

SENSOR	EXCITATION WAVELENGTH (NOMINAL)	DETECTION WAVELENGTH
Fluorescein WT	462 nm	525 nm to 570 nm

## Fluorescein WT Concentration



Fluorescein WT Concentration is available to read by default and does not require an empirical scale factor like other fluorometer readings.

Fluorescein is one of the most heavily studied fluorescent molecules in many fields. It is best known as the colorant in anti-freeze and some gasolines. As such, it was an early adopted water tracer. Due to toxicity and lingering environmental presence, it has largely been replaced by Rhodamine WT. However, it is still in wide use since a lot of its properties including its extinction coefficient, temperature behavior, and interactions with the environment are well studied.

Many other fluorometers require an empirical correlation to derive meaningful parameters for a specific deployment site. Because Fluorescein WT is a standardized compound that is not subject to biological variations, concentration can be calculated directly from fluorescence without the need for a site-specific scale factor. Every 1 RFU increase represents an increase of 5 ug/L of Fluorescein WT. Fluorescein concentration is calculated using methods from:

P.L. Smart, I.M.S. Laidlaw, An evaluation of some fluorescent dyes for water tracing. Water Resources Research, Vol. 13, No. 1 Feb. 1977

## Additional Information

For additional sensor details including accuracy, range, resolution, methodology, detection limits, response time, and more, see the Aqua TROLL sensor specification sheet at [www.in-situ.com](http://www.in-situ.com).

For more information about this parameter including application information, parameter calculation equations, sensor design, and more, view the parameter page at [www.in-situ.com](http://www.in-situ.com).

## Installation Requirements



The calculation of fluorescein concentration depends on temperature. For the fastest response time, use the Fluorescein WT sensor with a dedicated Temperature or Temperature/Conductivity sensor.



Fluorometers do not require special preparation. Apply a thin layer of grease to the connector O-rings before installing any sensor in the instrument.



Use caution when deploying in direct sunlight or environments with highly-reflective surfaces. Although the sensor's filters reduce the effects of ambient light, very high light levels can interfere with readings.

## Chemical Incompatibility



Do not soak the sensor in solvents, such as chlorinated solvents, ethers, or ketones, such as acetone. Do not use metal scraping tools to clean the sensor. Follow the cleaning procedure described below.

## Cleaning



Rinse the sensor face with clean, cold water. If further cleaning is needed, clean the sensor based on the nature of the debris. Begin with the gentlest method and continue to the others only if necessary.

### TO REMOVE SOFT FOULING:



1 Clean the sensor with warm water and mild soap.



2 Soak the sensor in dish soap and warm water.



3 Use a soft brush to gently clean all debris from the optical window.



4 Thoroughly rinse the sensor with deionized water.

### TO REMOVE HARD FOULING:



1 Clean the sensor with warm water and mild soap.



2 Soak the sensor in dilute vinegar.



3 Use a soft brush to gently clean all debris from the optical window.



4 Thoroughly rinse the sensor with deionized water.

# Recommended Calibration Frequency

Calibrating a fluorometer adjusts the relative fluorescence measured by the sensor by applying a slope and offset to the factory-calibrated values. In-Situ's sensors are rigorously calibrated in our factory across their full range and maintain linear fluorescence readings without need for user calibration.

You can calibrate the sensor to compensate for physical changes to the lens or if you have Standard Operating Procedures that require calibration. Choose **Restore Calibration Defaults** from **Instrument Settings** to return to the last factory calibration.

Calibrate the Fluorescein WT sensor using one of two methods:

- 1. Deionized Water:** Reset the zero point by performing a calibration in deionized water.
- 2. Solid State Calibrator:** Use the Fluorescein WT Solid State RFU Calibrator as a stable and repeatable solid-state standard to perform RFU calibrations and checks on the Aqua TROLL Fluorescein WT sensor. Calibrate the sensor to the standard value and use the same standard to check your sensor to ensure the sensor response has not changed over time.

# Calibration Procedure



If possible, use the solid state calibrator provided by In-Situ rather than a liquid standard. If solution-based calibration is required, pour solution all the way to the bottom of the restrictor threads. Fluorometers require more calibration solution than other solution-based calibrations.



You can batch calibrate a group of sensors at the same time to reduce time and calibration solution.

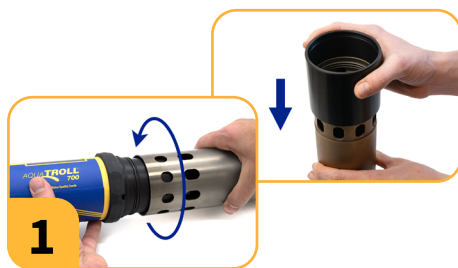

Place the restrictor in calibration mode (holes near the center of the instrument). If you are using a copper restrictor, install the calibration sleeve.

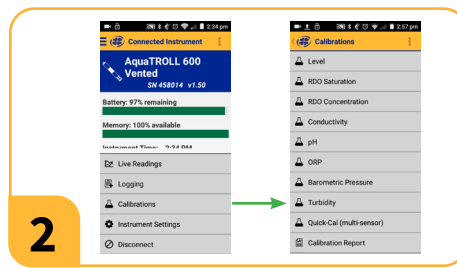

In VuSitu, click Calibrations from the Connected Instrument screen and choose sensor to calibrate.



Remove cap from instrument and pour DI water into restrictor. Use 10-20 mL for Aqua TROLL 500 or 600. Use 20-40 mL for Aqua TROLL 700 or 800.



Gently shake the sonde in a circular motion to rinse the inside of restrictor and sensors, then discard the DI water. Because fluorescence is an optical measurement, rinsing with calibration solution is not necessary.



Place the calibrator in the end of the restrictor. Take note of the standard value from the top of the calibrator.

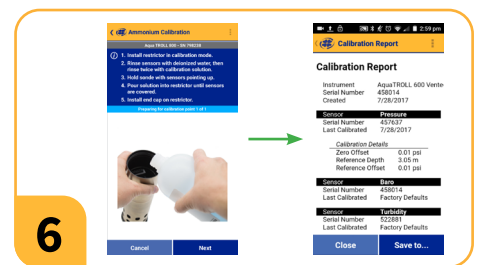

Follow the instructions in VuSitu to start the calibration. Enter the standard value from the top of the calibrator when prompted in VuSitu.

## Checking Calibration Quality



After calibration, check these indicators in the VuSitu Calibration Report. If you are logged in, Calibration Reports will automatically upload to HydroVu for secure storage and access from any device.

INDICATOR	ACCEPTABLE RANGE	NOTES
Slope	0.7 to 1.3	A sensor at factory defaults will have a slope of 1.

If the values are outside of the ranges listed above, follow these troubleshooting steps. Then try the calibration again.

- Thoroughly clean, rinse, and dry the sensor, restrictor, and calibration equipment.
- Check that calibration solutions are not expired.
- From **Instrument Settings**, select **Restore Calibration Defaults**. Then try calibrating again.
- Inspect the lenses for scratches, smudges, or condensation inside the sensor. If you notice major scratches or internal condensation and the sensor is not calibrating properly, you may need to replace your sensor.
- Make sure the sensor has been stored properly according to the instructions in this manual.
- Check whether the sensor is reaching the end of its expected life. It may be time to replace your sensor.

## Shelf Life for In-Situ Solutions

SOLUTION	SHELF LIFE - UNOPENED	SHELF LIFE - OPENED
Deionized Water	24 months	Hours, check before use for calibration

## Maintenance



Fluorometers do not have unique maintenance requirements aside from cleaning as described in this manual. Change the connector O-rings as part of routine instrument maintenance.

## Storage



Fluorometers do not have any unique storage requirements. They can be stored wet or dry. Cover the connector with the included dust cover when it is not in use to protect the connector from corrosion or fouling.

## Expected Sensor Life

Follow all recommendations in this manual to maximize the life of your sensor. Fluorometers can last years depending on site and storage conditions. The lifetime may be reduced if the instrument is installed in abrasive or corrosive conditions, cleaned improperly, or deployed outside of its operational temperature and pressure ranges.

# Service and Repair

## Obtaining Repair Service

If you suspect your system is malfunctioning and repair is needed, you can help assure efficient servicing by following these guidelines:

1. Call or email In-Situ Technical Support. Have the product model and serial number available.
2. Be prepared to describe the problem, including how the product was used and the conditions noted at the time of the malfunction.
3. If Technical Support determines that service is needed, they will ask your company to fill out the RMA form and pre-approve a specified monetary amount for repair charges. When the form and pre-approval is received, Technical Support will assign an RMA (Return Material Authorization) number.
4. Clean the product as described in the manual.
5. If the product contains a removable battery, remove and retain it unless you are returning the system for a refund or Technical Support states otherwise.
6. Carefully pack your product in its original shipping box, if possible.
7. Mark the RMA number clearly on the outside of the box.
8. Send the package, shipping prepaid, to:

In-Situ:

ATTN: Repairs

221 East Lincoln Avenue

Fort Collins, CO 80524

The warranty does not cover damage during transit. In-Situ recommends insurance for all shipments. Warranty repairs will be shipped back prepaid.

### Outside the U.S.

Contact your international In-Situ distributor for repair and service information.

## Guidelines for Cleaning Returned Equipment

Please help us protect the health and safety of our employees by cleaning and decontaminating equipment that has been subjected to potential biological or health hazards, and labeling such equipment. Unfortunately, we cannot service your equipment without such notification. Please complete and sign the form (or a similar statement certifying that the equipment has been cleaned and decontaminated) and send it to us with each instrument.

1. We recommend cleaning with only mild soaps that are compatible with the product materials. Wetted materials lists are provided on the product specification sheets. Clean all cables and remove all foreign matter.
2. Clean the cable connectors with a clean, dry cloth. Do not submerge the connectors.
3. Clean the instrument including the restrictor, sensor faces, and sonde body.



If an instrument is returned to our Service Center for repair or recalibration without a statement that it has been cleaned and decontaminated, or if it is the opinion of our Service Representatives that the equipment presents a potential health or biological hazard, we reserve the right to withhold service until proper certification is obtained.

## Decontamination & Cleaning Statement

Company Name	Phone
Address	
City	State
Instrument Type	Serial Number
Contaminant(s) if known)	
Decontamination procedure(s) used	
Cleaning verified by	Title
Date	



## Aqua TROLL® 600 Multiparameter Sonde

**THE AQUA TROLL® 600 IS A FULLY CUSTOMIZABLE MULTIPARAMETER SONDE WITH INTERCHANGEABLE WATER QUALITY SENSORS AND A MOBILE APP INTERFACE THAT ENABLES SIMPLIFIED CALIBRATION, EASY SET UP AND AUTOMATIC DATA UPLOADS TO THE CLOUD.**

The Aqua TROLL® 600 is a five-port multiparameter sonde, including four sensor ports and a wiper port. There is an option to have an antifouling wiper to ensure data accuracy.

The Aqua TROLL® is optimized for long-term monitoring of water quality in the harshest environments. Monitoring experts appreciate low energy use that lengthens maintenance cycles, and an integrated LCD for checking deployment readiness, battery life and sensor status. Use as a standalone data logger, or protect your data in case of unplanned telemetry interruptions. All features are delivered through a simplified user experience that makes this advanced technology accessible to everyone.

### SIMPLIFIED USER EXPERIENCE

All Aqua TROLL® products use our industry-leading ecosystem, which includes:

- VuSitu mobile app with live data and in-app guidance through setup and calibration
- HydroVu software for anywhere, anytime data visibility of your data
- Data files that sync automatically to HydroVu for secure access on any device
- Sensors that can be used across multiple products, saving time and expense
- Common cables, communication device and VuLink telemetry

### EXTENDED DEPLOYMENT DESIGN

The Aqua TROLL® 600 was designed with features that make it easier to extend deployments and reduce site-visit maintenance time.

- Interlocking sensors reduce surfaces for fouling
- Dual-sided antifouling wiper cleans sensors and restrictor simultaneously
- Optional copper restrictor

### BUILT-IN ERROR PREVENTION

Prevent the most common damage or loss with:

- Spring-loaded screws that stay in place
- Smart sensors that fit in any port
- Wet-mate connectors that prevent water damage
- Anti-roll bumpers to keep equipment stationary
- Slip-clutch wiper that prevents motor damage
- Titanium Twist-Lock connector and Kevlar-reinforced cable

### WIDE RANGE OF PARAMETERS AVAILABLE

Available sensors include Rugged Dissolved Oxygen (RDO®), temperature, conductivity, pH, ORP, turbidity, chlorophyll a, phycocyanin (BGA-PC), phycoerythrin (BGA-PE), fluorescent dissolved organic matter (FDOM), crude oil, Rhodamine WT, ammonium, chloride, and nitrate. Enable additional derived parameters, or calculate custom parameters from HydroVu. See the Aqua TROLL Sensors spec sheet for specifications and features.

### LOWER CALIBRATION COSTS

The Aqua TROLL® 600 uses less than 50 ml of solution for most calibrations, reducing calibration cost by 5x over traditional methods and saving thousands of dollars in calibration solution per year. In-app instructions ensure consistency and accuracy with every calibration.



GENERAL		AQUA TROLL 600 MULTIPARAMETER SONDE	
<b>OPERATING TEMPERATURE (NON-FREEZING)</b>	-5 to 50° C (23 to 122° F) ISE: Ammonium & Nitrate 0 to 40° C (32 to 104° F); Chloride 0 to 50° C (32 to 122° F)		
<b>STORAGE TEMPERATURE</b>	Components w/o fluid: -40° C to 65° C (-40° to 149° F) (non-freezing water); pH/ORP: -5° C to 65° C (-23° to 149° F); Ammonium/Nitrate: 0 to 40° C (32° to 104° F); Chloride: 0 to 50° C (32° to 122° F)		
<b>DIMENSIONS</b>	Diameter: 4.7 cm (1.85 in) OD Length: 60.2 cm (23.7 in) (inc. connector) Length With bail: 72.9 cm (28.7 in)		
<b>WETTED MATERIALS</b>	Polyphenylsulfone, Polycarbonate, Acetal, EPDM/Polypropylene TPV, FKM Fluoroelastomer, Titanium, Fluorocarbon Coating, Ceramic, Inconel, Acrylic Adhesive Film, Nylon, Polyurethane Adhesive, Graphite, PC/PMMA Blend, Acrylic, Sapphire, PVC, Platinum, Glass, Proprietary RDO Sensing Formulation		
<b>WEIGHT<sup>1</sup></b>	1.45 kg / 3.2 lbs (includes all sensors, batteries, and bail)		
<b>MAX PRESSURE RATING</b>	Up to 350 PSI		
<b>COMMUNICATION OPTIONS</b>	RS-485/MODBUS, SDI-12, Bluetooth		
<b>READING RATES</b>	1 reading every 2 seconds		
<b>DATA LOGGING</b>	Store up to 50 log files		
<b>LOGGING RATE</b>	1 minute to 99 hours		
<b>ENVIRONMENTAL RATING</b>	IP68 with all sensors and cable attached IP67 without the sensors or cable attached		
<b>INTERNAL MEMORY<sup>2</sup></b>	16 MB		
<b>MICRO SD CARD<sup>3</sup></b>	8+ GB micro SD card included, user replaceable		
<b>INTERNAL POWER</b>	2 user-replaceable Alkaline D batteries		
<b>BATTERY LIFE<sup>4</sup></b>	> 6 months typical with wiping > 9 months typical with no wiping		
<b>EXTERNAL POWER<sup>6</sup></b>	8-36 VDC (not required for normal operation); Sleep: 0.1 mA typical Measurement: 16 mA typical; 45 mA max		
<b>HEX SCREW DRIVER</b>	1.3 mm, 0.050 in		
<b>COMMUNICATION DEVICE</b>	TROLL Com Plus or VuLink		
<b>CABLE OPTIONS</b>	Vented or non-vented polyurethane or vented Tefzel® Twist-Lock or Flying Leads termination		
<b>LCD DISPLAY</b>	Integrated display shows status of sonde, sensor ports, connectivity, power information, battery capacity and data log status		
<b>SOFTWARE</b>	Android: VuSitu through Google Play and Amazon App Store iOS: VuSitu through Apple App Store		
<b>CERTIFICATIONS</b>	CE, FCC, WEEE, RoHS Compliant		
<b>DATA SERVICES</b>	HydroVu		

SENSOR	ACCURACY	RANGE	RESOLUTION/PRECISION	RESPONSE TIME	UNITS OF MEASURE
<b>PRESSURE (OPTIONAL)<sup>5</sup></b>	±0.1% FS from -5 to 50°C	Non-Vented or Vented 0-9 m (0-30 ft) 0-30 m (0-98 ft) 0-76 m (0-250 ft) 0-200 m (0-650 ft)	0.01% full scale	T63<1s, T90<1s, T95<1s	Pressure: psi, kPa, bar, mbar, inHg, mmHg Level: in, ft, mm, cm, m, cmH2O, inH2O
<b>BAROMETRIC PRESSURE</b>	± 1.0 mbars	300 to 1,100 mbar	0.1 mbar	T63<1s, T90<1s, T95<1s	psi, kPa, bar, mbar, inHg, mmHg

**NOTES:** <sup>1</sup>Weight includes sonde, sensors, wiper, batteries, and bail. <sup>2</sup>For 30 parameters > 100,000 data records, > 3 years at 15 min. interval. A single data record includes timestamp, temperature, RDO, pH, ORP, turbidity and conductivity logged in Linear or Linear Average mode. <sup>3</sup>Log data recorded to SD card in comma delimited variable (CSV) file format. Greater than 32 GB not supported. <sup>4</sup>Logging all sensors at 15 min interval on 2 D Alkaline batteries. Battery life dependent on site conditions and wiping. <sup>5</sup>User-defined reference. <sup>6</sup>Current from an external power source must not exceed 4 amps.

For interchangeable sensor specifications, see the sensor spec sheet. Specifications are subject to change without notice.

**WARRANTY:** 2 year - Sonde, wiper. 1 year - Accessories. See warranty policy ([www.in-situ.com/warranty](http://www.in-situ.com/warranty)) for full details. See the Aqua TROLL Sensors Spec Sheet for sensor warranty information.

**in-situ.com**

Copyright © 2026 In-Situ Inc. All rights reserved. January 2026



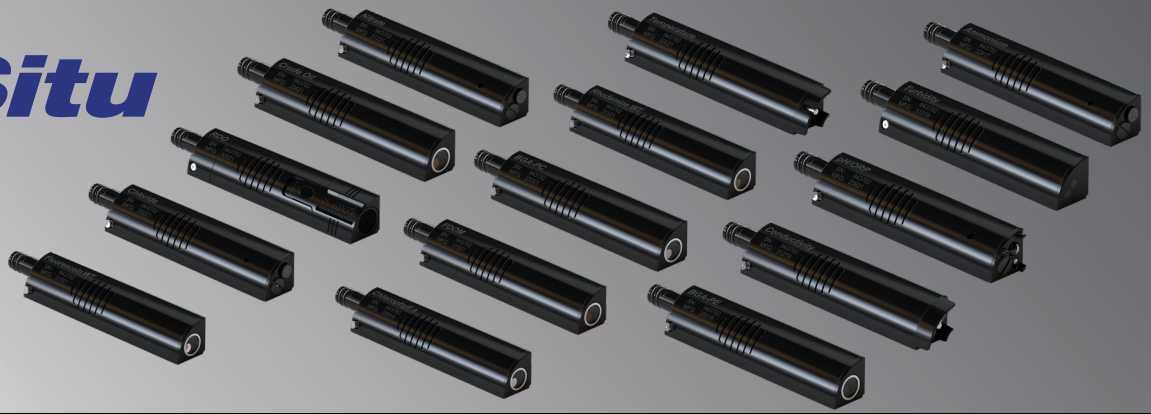

## Aqua TROLL® Sensors

**THE FULL RANGE OF AQUA TROLL SENSORS ARE DESIGNED FOR SEAMLESS INTEGRATION WITH THE CUSTOMIZABLE AQUA TROLL 500, 600, 700, AND 800 MULTIPARAMETER SONDES.**

These smart, interchangeable sensors deliver high-accuracy data across a wide range of water quality parameters and are optimized for simplified calibration, fast sensor swaps, and reliable performance in any monitoring environment.

Each sensor is automatically recognized by the sonde and the VuSitu® mobile app, enabling plug-and-play configuration, automated calibration tracking, and streamlined data collection and reporting. Whether you're spot-checking with a TROLL® Com Plus and smartphone, or deploying for continuous monitoring with VuLink® telemetry and HydroVu® cloud services, these sensors power a flexible, efficient workflow.

The Aqua TROLL 500 and 600 sondes accommodate up to four sensors, while the Aqua TROLL 700 and 800 support up to six—plus a central wiper port for antifouling protection. All sensors are compatible across vented and non-vented models and built to perform in the most challenging field conditions.



### AQUA TROLL SENSORS

Available sensors include Rugged Dissolved Oxygen (RDO®), temperature, conductivity, pH/ORP, turbidity, chlorophyll a, phycocyanin (BGA-PC), phycoerythrin (BGA-PE), fluorescent dissolved organic matter (FDOM), crude oil, Rhodamine WT, Fluorescein WT, ammonium, chloride, and nitrate.

### EXTENDED DEPLOYMENT

In-Situ's patented flat-faced interlocking sensor design enables cleaning of all sensors with the wiper. Dual-sided wiper cleans sensors and restrictor. Interlocking sensors eliminate the growth of fouling on sensor bodies. Copper alloy restrictors can be used to extend deployments.

### VUSITU CALIBRATION ASSISTANCE

The VuSitu mobile app provides step-by-step guidance for intuitive, consistent calibrations. Save time and solution by calibrating multiple sensors of the same type at once in our Aqua TROLL platforms with the built-in mini calibration cup. VuSitu's auto-compensation ensures calibration values are accurate. Instantly back calibration reports up to HydroVu and find them easily by sensor, instrument, or calibration date.

### 3D FACTORY CALIBRATION

In-Situ performs a multi-point factory calibration on every sensor, to ensure that the sensor is linear across its full range and simplify calibration for the user.

SENSOR	ACCURACY	RANGE	RESOLUTION/PRECISION	RESPONSE TIME	UNITS OF MEASURE	METHODOLOGY COMPLIANCE
TEMPERATURE <sup>1</sup>	± 0.1° C	-5 to 50° C (23 to 122° F)	0.001° C	T63<2s, T90<15s, T95<30s	Celsius or Fahrenheit	EPA 170.1
pH <sup>2</sup>	±0.1 pH unit or better	0 to 14 pH units	0.01 pH	T63<3s, T90<15s, T95<30s	pH, mV	Std. Methods 4500-H+/EPA 150.2
ORP <sup>3</sup>	±5 mV	±1,400 mV	0.1 mV	T63<3s, T90<15s, T95<30s	mV	Std. Methods 2580
CONDUCTIVITY <sup>4</sup>	±0.5% of reading plus 1 µS/cm from 0 to 100,000 µS/cm; ±1.0% of reading from 100,000 to 200,000 µS/cm; ±2.0% of reading from 200,000 to 350,000 µS/cm	0 to 350,000 µS/cm	0.1 µS/cm	T63<1s, T90<3s, T95<5s	Conductivity (µS/cm, mS/cm); Specific conductivity (µS/cm, mS/cm); Resistivity (Ohms/cm); Density (g/cm <sup>3</sup> )	Std. Methods 2510/ EPA 120.1 ±1,400 mV
TDS (DERIVED FROM CONDUCTIVITY AND TEMP)	--	0 to 350 ppt	0.1 ppt	--	ppt, ppm	--
SALINITY (DERIVED FROM CONDUCTIVITY AND TEMP)	--	0 to 350 PSU	0.1 PSU	--	PSU, ppt	Derived from Std. Methods 2520B PSS-78 available as an alternative method option
RUGGED DISSOLVED OXYGEN (RDO) WITH RDO-X <sup>5</sup> OR RDO FAST CAP	Concentration: ±0.1 mg/L from 0-20 mg/L ±5% of reading from 20 mg/L to 60 mg/L Saturation: ±1% of reading or ± 1% saturation, whichever is greater, from 0-200% saturation ±5% of reading from 200-500% saturation	0 to 60 mg/L 0 to 500% saturation	0.01 mg/L 0.1% saturation	RDO-X: T63<15s, T90<45s, T95<60s Fast Cap: T63<3s, T90<30s, T95<45s	mg/L, % saturation, ppm	EPA-approved In-Situ Methods: 1002-8-2009, 1003-8-2009, 1004-8-2009 Compliant with ASTM D888-18 Method C and ISO 17289 methods
TURBIDITY	±2% of reading or ±0.5 NTU, FNU, whichever is greater	0 - 4,000 NTU	0.01 NTU from 0-1000; 0.1 NTU from 1000-4000	T63<1s, T90<1s, T95<1s	NTU, FNU ppt, mg/L	ISO 7027
TSS (DERIVED FROM TURBIDITY) <sup>6</sup>	--	0 to 1,500 mg/L	0.1 mg/L	--	--	--
AMMONIUM (NH <sub>4</sub> <sup>+</sup> -N) <sup>7,8</sup> RATED TO 25 m DEPTH -Unionized Ammonia, Total Ammonia (derived from Ammonium & pH sensor)	±10% or ±2 mg/L w.i.g.	0 to 10,000 mg/L as N	0.01 mg/L	T63<1s, T90<10s, T95<30s	mg/L, ppm, mV	--
	--	0 to 10,000 mg/L as N	0.01 mg/L	--	mg/L, ppm	--
NITRATE (NO <sub>3</sub> <sup>-</sup> -N) <sup>9</sup> RATED TO 25 m DEPTH	±10% or ±2 mg/L w.i.g.	0 to 40,000 mg/L as N	0.01 mg/L	T63<1s, T90<10s, T95<30s	mg/L, ppm, mV	Std. Methods 4500 NO <sub>3</sub> -D
CHLORIDE (CL <sup>-</sup> ) <sup>9</sup>	±10% or ±2 mg/L w.i.g.	0 to 150,000 mg/L as Cl	0.01 mg/L	T63<1s, T90<10s, T95<30s	mg/L, ppm, mV	Std. Methods 4500 Cl-D

SENSOR	LINEARITY	INSTRUMENT DETECTION LIMIT	RANGE	DISPLAY RESOLUTION	RESPONSE TIME	DEFAULT UNIT(S)	DERIVED PARAMETERS <sup>6</sup>
Chlorophyll a	R <sup>2</sup> >0.999 for serial dilutions of Chl a in MeOH across full range	0.1 µg/L Chl a in MeOH	0-100 RFU 0-1000 µg/L	0.001 RFU	T63<1s, T90<1s, T95<1s	RFU	Chlorophyll a concentration Chlorophyll a cell count
Phycocyanin (BGA-PC)	R <sup>2</sup> >0.999 for serial dilutions of PC standard across full range	1.0 µg/L PC standard	0-100 RFU 0-1000 µg/L	0.001 RFU	T63<1s, T90<1s, T95<1s	RFU	Phycocyanin Concentration BGA-PC Cell Count
Phycoerythrin (BGA-PE)	R <sup>2</sup> >0.999 for serial dilutions of PE standard across full range	0.5 µg/L PE standard	0-100 RFU 0-1000 µg/L	0.001 RFU	T63<1s, T90<1s, T95<1s	RFU	Phycoerythrin Concentration BGA-PE Cell Count
FDOM	R <sup>2</sup> >0.999 for serial dilutions of Quinine Sulfate across full range	0.5 µg/L Quinine Sulfate	0-100 RFU 0-3000 µg/L	0.001 RFU	T63<1s, T90<1s, T95<1s	RFU	FDOM Concentration CDOM Concentration
Crude Oil	R <sup>2</sup> >0.999 for serial dilutions of PTSA across full range	1.0 µg/L PTSA	0-100 RFU 0-3000 µg/L	0.001 RFU	T63<1s, T90<1s, T95<1s	RFU	Crude Oil Concentration
Rhodamine WT	R <sup>2</sup> >0.999 for serial dilutions of RWT across full range	0.5 µg/L Rhodamine WT	0-100 RFU 0-1000 µg/L	0.001 RFU	T63<1s, T90<1s, T95<1s	RFU, µg/L	
Fluorescein WT	R <sup>2</sup> >0.999 for serial dilutions of FWT across full range	0.2 µg/L Fluorescein WT	0-100 RFU 0-500 µg/L	0.001 RFU	T63<1s, T90<1s, T95<1s	RFU, µg/L	

**NOTES:** <sup>1</sup> Typical system response with instrument, sensors and restrictor when changing approximately 15°C in moderate flow. Resolution as displayed in HydroVu. <sup>2</sup>Response time at thermal equilibrium. <sup>3</sup>Accuracy from calibration standard @ 25C, response at thermal equilibrium immediately following calibration measuring from air to +400 mV. <sup>4</sup>Accuracy at calibration points. <sup>5</sup>RDO sensor full range 0-60 mg/L, 0-600% sat. EPA-approved method under the Alternate Test Procedure Process. <sup>6</sup>User-defined reference. <sup>7</sup>Between 2 calibration points immediately following proper conditioning and calibration. Varies on site conditions and environmental interferences. See instrument manual for potential interferences. <sup>8</sup>Average response; can be longer with increasing concentrations of ammonium. <sup>9</sup>Typical performance across full temperature and pressure calibrated range.

See the instrument specification sheet for sonde specifications. Specifications are subject to change without notice.

**WARRANTY:** 2 year – RDO and Sensor Cap, Temperature/Conductivity, Temperature Only, Turbidity, Chlorophyll a, pH/ORP, Phycocyanin (BGA-PC), Phycoerythrin (BGA-PE), Rhodamine WT.  
1 year - Chloride ISE. 90 days - Nitrate and Ammonium ISE Sensors. See warranty policy ([www.in-situ.com/warranty](http://www.in-situ.com/warranty)) for full details.

# More Information



To learn more about the Aqua TROLL 600, telemetry, software and other In-Situ products, see the resources listed below.

## 1 Visit [www.in-situ.com](http://www.in-situ.com)

Find information about In-Situ water quality, water level, telemetry and other products. Download software, manuals and product instructions.

## 2 View the In-Situ YouTube channel.

Get video instructions for the Aqua TROLL 600 and other instruments. Watch quickstart videos and other tutorials.

## 3 Call In-Situ's technical support team.

For further instructions and help with technical questions, call the In-Situ support line at 1-970-498-1500.

# Declaration of Conformity



## In-Situ

Innovations in **Water Monitoring**

### CE Declaration of Conformity

Manufacturer: In-Situ, Inc.  
221 East Lincoln Avenue, Fort Collins, CO 80524, USA

Declares that the following product:

Product name: **Aqua TROLL® 600 Multiparameter Sonde**

Model: **Aqua TROLL® 600**

Part Number: **0096400, 0074030, 0074040, 0074050, 0074060, 0074070, 0074080, 0074090, 0074100, 0074110**

Product Description: **Multiparameter water quality data logger**

Model Variants: The Aqua TROLL 600 is available as No Pressure sensor, Non-Vented and Vented variants. The non-vented and vented variants are available in four different pressure ranges: 0-9m, 0-30m 0-76m and 0-200m.

is in compliance with the following Directive

- Radio Equipment Directive (RED), 2014/53/EU
- Restriction of the use of certain hazardous substances in electrical and electronic equipment (RoHS) Directive, 2011/65/EU and Commission Delegated Directive, (EU) 2015/863

and meets or exceeds the following international requirements and compliance standards:

**Radio Equipment Directive Article 3.1(a) Safety Standards:**

IEC61010-1:2010 + A1:2019

**Radio Equipment Directive Article 3.1(b) EMC Standards:**

ETSI EN 301 489-1 V2.2.3

ETSI EN 301 489-17 V3.1.1

**Radio Equipment Directive Article 3.2 Radio Standards:**

EN 300 328 V2.2.2

EN 62311:2019

**RoHS Standard:**

EN IEN 63000:2018

The CE mark is affixed accordingly.

Ben Kimbell  
VP of R&D  
In-Situ, Inc.  
March 12, 2022



WWW.IN-SITU.COM

221 East Lincoln Avenue, Fort Collins, CO 80524 USA

Toll Free: 800.446.7488 Tel: 970.498.1500 Fax: 970.498.1598

Copyright © 2015 In-Situ Inc. This document is confidential and is the property of In-Situ Inc. Do not distribute without approval.



## UKCA Declaration of Conformity

Manufacturer: In-Situ, Inc.  
221 East Lincoln Avenue, Fort Collins, CO 80524, USA

We declare that the performance of the following product:

Product name: **Aqua TROLL® 600 Multiparameter Sonde**

Model: **Aqua TROLL® 600**

Part Number: **0096400, 0074030, 0074040, 0074050, 0074060, 0074070, 0074080, 0074090, 0074100, 0074110**

Product Description: **Multiparameter water quality data logger**

Model Variants: The Aqua TROLL 600 is available as No Pressure sensor, Non-Vented and Vented variants. The non-vented and vented variants are available in four different pressure ranges: 0-9m, 0-30m 0-76m and 0-200m.

is in compliance with the following Regulations:

- Radio Equipment Regulation 2017 (S.I. 2016:1206)
- Restriction of the use of certain hazardous substances in electrical and electronic equipment (RoHS) Regulation (S.I. 2012:3032)
- Electrical Equipment (Safety) Regulation 2016 (S.I. 2016:1101)

and meets or exceeds the following British requirements and compliance standards:

- **Safety:** BS 61010-1:2010 + AMD 1:2019
- **Immunity:** BS EN 61000-6-2:2019
- **Emissions:** BS EN 55024:2010 + A1:2015

The UKCA mark is affixed accordingly.

Ben Kimbell  
VP of R&D  
In-Situ, Inc.  
February 23, 2022



# Appendix

## Appendix A: Parameter Numbers and Locations

ID	PARAMETER NAME	HOLDING REGISTER NUMBER	HOLDING REGISTER ADDRESS	DEFAULT UNITS
1	Temperature	45451	5450	1 = °C
2	Pressure	45458	5457	17 = PSI
3	Depth	45465	5464	38 = feet
4	Level, Depth to Water	45472	5471	38 = feet
5	Level, Surface Elevation	45479	5478	38 = feet
9	Actual Conductivity	45507	5506	65 = μS/cm
10	Specific Conductivity	45514	5513	65 = μS/cm
11	Resistivity	45521	5520	81 = ohm-cm
12	Salinity	45528	5527	97 = PSU
13	Total Dissolved Solids	45535	5534	114 = ppt
14	Density of Water	45542	5541	129 = g/cm <sup>3</sup>
16	Barometric Pressure	45556	5555	22 = mmHg
17	pH	45563	5562	145 = pH
18	pH mV	45570	5569	162 = mV
19	ORP	45577	5576	162 = mV
20	Dissolved Oxygen Concentration	45584	5583	117 = mg/L
21	Dissolved Oxygen % Saturation	45591	5590	177 = % Saturation

24	Chloride (Cl <sup>-</sup> )	45612	5611	117 = mg/L
25	Turbidity	45619	5618	194 = NTU
30	Oxygen Partial Pressure	45654	5653	26 = torr
31	Total Suspended Solids	45661	5660	117 = mg/L
32	External Voltage	45668	5667	163 = Volts
33	Battery Capacity (remaining)	45675	5674	241 = %
34	Rhodamine WT Concentration	45682	5681	118 = µg/L
35	Rhodamine WT Fluorescence Intensity	45689	5688	257 = RFU
36	Chloride (Cl <sup>-</sup> ) mV	45696	5695	162 = mV
37	Nitrate as Nitrogen (NO <sub>3</sub> <sup>-</sup> -N) concentration	45703	5702	117 = mg/L
38	Nitrate (NO <sub>3</sub> <sup>-</sup> ) mV	45710	5709	162 = mV
39	Ammonium as Nitrogen (NH <sub>4</sub> <sup>+</sup> -N) concentration	45717	5716	117 = mg/L
40	Ammonium (NH <sub>4</sub> ) mV	45724	5723	162 = mV
41	Ammonia as Nitrogen (NH <sub>3</sub> -N) concentration	45731	5730	117 = mg/L
42	Total Ammonia as Nitrogen (NH <sub>3</sub> -N) concentration	45738	5737	117 = mg/L
50	Chlorophyll-a Concentration	45794	5793	118 = µg/L
51	Chlorophyll-a Fluorescence Intensity	45801	5800	257 = RFU

54	Blue Green Algae-Phycocyanin Concentration	45822	5821	118 = µg/L
55	Blue Green Algae-Phycocyanin Fluorescence Intensity	45829	5828	257 = RFU
58	Blue Green Algae-Phycoerythrin Concentration	45850	5849	118 = µg/L
59	Blue Green Algae-Phycoerythrin Fluorescence Intensity	45857	5856	257 = RFU
67	Fluorescein WT Concentration	45913	5912	118 = µg/L
68	Fluorescein WT Fluorescence Intensity	45920	5919	257 = RFU
69	Fluorescent Dissolved Organic Matter Concentration	45927	5926	118 = µg/L
70	Fluorescent Dissolved Organic Matter Fluorescence Intensity	45934	5933	257 = RFU
80	Crude Oil Concentration	46004	6003	118 = µg/L
81	Crude Oil Fluorescence Intensity	46011	6010	257 = RFU
87	Colored Dissolved Organic Matter Concentration	46053	6052	118 = µg/L

## Appendix B: Unit IDs

ID	ABBREVIATION	UNITS
1	C	Celsius
2	F	Fahrenheit
3	K	Kelvin
<b>PRESSURE, BAROMETRIC PRESSURE (17-32)</b>		
17	PSI	Pounds per square inch
18	Pa	Pascals
19	kPa	Kilopascals
20	Bar	Bars
21	mBar	Millibars
22	mmHg	Millimeters of Mercury (0 to C)
23	inHg	Inches of Mercury (4 to C)
24	cmH <sub>2</sub> O	Centimeters of water (4 to C)
25	inH <sub>2</sub> O	Inches of water (4 to C)
26	Torr	Torr
27	atm	Standard atmosphere
<b>DISTANCE/LENGTH (33-48)</b>		
33	mm	Millimeters
34	cm	Centimeters
35	m	Meters
36	km	Kilometer
37	in	Inches
38	ft	Feet
<b>COORDINATES (49-64)</b>		
49	deg	Degrees

50	min	Minutes
51	sec	Seconds
<b>CONDUCTIVITY (65-80)</b>		
65	$\mu\text{S/cm}$	Microsiemens per centimeter
66	mS/cm	Millisiemens per centimeter
<b>RESISTIVITY (81-96)</b>		
81	ohm-cm	Ohm-centimeters
<b>SALINITY (97-112)</b>		
97	PSU	Practical Salinity Units
98	ppt	Parts per thousand salinity
<b>CONCENTRATION</b>		
113	ppm	Parts per million
114	ppt	Parts per thousand
117	mg/L	Milligrams per liter
118	$\mu\text{g/L}$	Micrograms per liter
120	g/L	Grams per liter
121	ppb	Parts per billion
<b>DENSITY (129-144)</b>		
129	$\text{g/cm}^3$	Grams per cubic centimeter
<b>PH (145-160)</b>		
145	pH	pH
<b>VOLTAGE (161-176)</b>		
161	$\mu\text{V}$	Microvolts
162	mV	Millivolts
163	V	Volts
<b>DISSOLVED OXYGEN (DO) % SATURATION (177-192)</b>		

177	% sat	Percent saturation
<b>TURBIDITY (193-208)</b>		
193	FNU	Formazin nephelometric units
194	NTU	Nephelometric turbidity units
195	FTU	Formazin turbidity units
<b>FLOW (209-224)</b>		
209	ft <sup>3</sup> /s	Cubic feet per second
212	ft <sup>3</sup> /day	Cubic feet per day
213	gal/s	Gallons per second
214	gal/min	Gallons per minute
215	gal/hr	Gallons per hour
216	MGD	Millions of gallons per day
217	m <sup>3</sup> /sec	Cubic meters per second
219	m <sup>3</sup> /hr	Cubic meters per hour
221	L/s	Liters per second
222	ML/day	Millions of liters per day
223	mL/min	Milliliters per minute
224	kL/day	Thousands of liters per day
<b>VOLUME (225-240)</b>		
225	ft <sup>3</sup>	Cubic feet
226	gal	Gallons
227	Mgal	Millions of gallons
228	m <sup>3</sup>	Cubic meters
229	L	Liters
230	acre-ft	Acre feet
231	mL	Milliliters

232	ML	Millions of liters
233	kL	Thousands of liters
234	Acre-in	Acre inches
<b>% (241-256)</b>		
241	%	Percent
<b>FLUORESCENCE (257-2720)</b>		
257	RFU	Relative Fluorescence Units
<b>LOW-FLOW (273-288)</b>		
273	mL/sec	Milliliters per second
274	mL/hr	Milliliters per hour
275	L/min	Liters per minute
276	L/hr	Liters per hour
<b>CURRENT (289-304)</b>		
289	$\mu$ A	Microamps
290	mA	Milliamps
291	A	Amps
<b>VELOCITY (305-320)</b>		
305	ft/s	Feet per second
306	m/s	Meters per second